

Downee



**AUTOMATION &
GATE HARDWARE**

INDEX

3 PRO MOTORS

SLIDE MOTORS

Slide Motor Base Selector
Gate Rack
Access Control Bollard

SWING MOTORS

8 MOTOR SELECTOR

Quick guide - choose the best motor for the job.

22 PRO GATE ACCESSORIES

Photocells Remotes
Keypads
Solar Power kit
Locks

26 BOOM GATE

27 MOTOSHAF

Shutter Door Motorised Drum

28 NICE HOME

Slide Gate Motors
Swing Gate Motors
Accessories

34 SLIDING GATE HARDWARE

Track - Bolt Down
Track - In Ground
Track Joiners
Wheels
Guide Rollers
Roller Guides
Top Guides
Parrot Beak Lock Kits
Guide Blocks
Gate Stop
Gate Catches

40 CANTILEVER GATE SYSTEMS

41 CANTILEVER HARDWARE

Wheels
Track
Brackets
End Cups
Tension Bar

45 TELESCOPIC GATE KIT

46 DRIVEWAY SWING GATE

Bearing Hinges
Hinges - 180 Degree
Hinges - Pintle
Hinges - Clamp
Hinges - Butt
Gate Stops

OPTIMUM

OPTIMUM 800

Suitable for doors up to 800kg

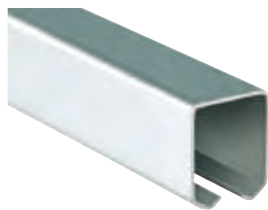

6m TRACK
800-6000



DOUBLE BRACKET
800-D
For 2 tracks, side-by-side



TRACK GUIDE
800-21



DOOR GUIDE ROLLER
800-BG
Floor or under-door mounted



TRACK GUIDE ROLLER
800-TG
Adds stability and security



OFFSET GUIDE
Offset bracket 800-1
Track guide 800-2



DOOR GUIDE WHEEL
800-GW



4-WHEEL CARRIER
Steel 800-4CS
Nylon 800-4CN
Steel roller bearings



OVERHEAD GUIDE
800-22



TOP DOOR STOP
246
Mount inside track



FLOOR STOP
300507B



LEVER BOLT
800-LL (open right-left, above)
800-LR (open left-right)
2-point top-bottom latch



HANDLE
800-H



DOOR CATCH
800-AG
Adjustable width

THE ULTIMATE SLIDING DOOR HARDWARE.

MADE IN ITALY
COMUNELLO

Visit us for more information at
www.downeesupport.com.au/slide-door-systems

300 SERIES



Door	120kg	200kg	250kg	300kg
Bracket (mm)	1200	1100	1000	900

uses 30% less
mount brackets

800 SERIES



Door	300kg	410kg	520kg	630kg	730kg	800kg
Bracket (mm)	1100	1000	900	800	700	600

uses 30% less
mount brackets

OPTIMUM 300

Suitable for doors up to 300kg

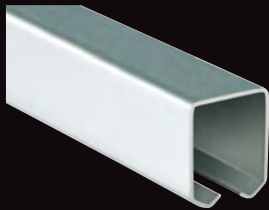

6m TRACK
300-6000



DOUBLE BRACKET
300-D
For 2 tracks, side-by-side



2-WHEEL CARRIER
Steel wheels 300-2CS
Nylon wheels 300-2CN
Steel roller bearings



4-WHEEL CARRIER
Steel wheels 300-4CS
Nylon wheels 300-4CN
Steel roller bearings



LEVER BOLT
300-LL (open right-left, above)
300-LR (open left-right)
2-point top-bottom latch



TRACK GUIDE
300-21



OFFSET GUIDE
Angle bracket 300-1
Track guide 300-2



OVERHEAD GUIDE
300-22



HANDLE
800-H



DOOR GUIDE ROLLER
300-BG
Floor or under-door mounted

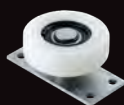

DOOR GUIDE WHEEL
300-GW



TOP DOOR STOP
300-TS
Mount inside track



FLOOR STOP
300507B

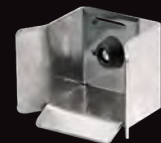

DOOR CATCH
300-AG
Adjustable width

APPS

Easy to install.
Easy to use.
Extra and ongoing income.

Call us now to discover how you can introduce APPS to your business.



INSTALLER APP

USER APP



SCLAK

Compatible with all electric locks and automation.

Sclak is simple to install on new or existing systems. Can be installed with keys, remote, swipe cards etc. without disrupting their function.

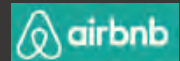

Official partner of Airbnb.

Visit us for intro videos at:
downeesupport.com.au/access-control-apps





FAST 24

24V / ^{up to} 500kg

POWER OPTIONS

- 230v at the gate
- External Transformer
- Solar



ALL METAL GEARS

TECH SPEC

MOTOR		24V
Motor Voltage	V	24(DC)
Motor Power	W	80
Duty Cycle	%	50
Opening Per Hour	5m gate	22
Opening Speed	m/min	16
Thrust Max.	N	240
Manufacturers Rating	kg	500
Protection Degree	IP	X4 (44 for Mag Switch)
Dimensions (H-W-D)	mm	320h 240w 188d
Motor Weight	kg	12
Working Temperature	°C	-20° to 40°
Cog Height	mm	81

REMOTE		
Remote	4 Channel	Rolling Codes

CONTROL BOARD		
Control Board		NET24
Input Power	V	24(DC)

OPTION

- Magnetic Limit Switch

20mm Base

LOLUXBASE-LOW
SUPPLIED AS STANDARD



35mm Base

AAC-FASTBASE

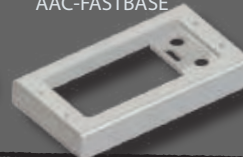

65mm Base

LOLUXBASE-HI

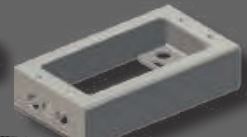

3 BASE OPTIONS

24V

KIT#1

24V Motor
No Remote
Controller + Receiver
20mm Base

FAST/24V

KIT#2

24V Motor
2 Remotes
Controller + Receiver
20mm Base

FAST/24V/START

EXTERNAL TRANSFORMER

KIT#3

24V Motor
No Remote
Controller + Receiver
20mm Base
External Transformer

FAST/24VSP

KIT CONTENTS



Motor



Ziggy

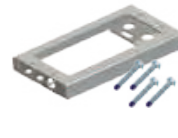

20mm Base



External Transformer

XT KITS ONLY

LOLUX



24V

EXTERNAL TRANSFORMER

230V

KIT#1

- 24V Motor
- 20mm Base
- 2 Remotes
- Controller + Receiver

LOLUX

KIT#2

- 24V Motor
- 20mm Base
- 4 Remotes
- Controller + Receiver
- 10m Reflective Sensor
- Booster Aerial

LOLUX-PRO

KIT#3

- 24V Motor
- 20mm Base
- 2 Remotes
- Controller + Receiver
- External Transformer

LOLUX-SP

KIT#4

- 24V Motor
- 20mm Base
- 4 Remotes
- Controller + Receiver
- 10m Reflective Sensor
- Booster Aerial
- External Transformer

LOLUX-PRO-SP

KIT#5

- 230V Motor
- 20mm Base
- 2 Remotes
- Controller + Receiver

LOLUX230

KIT#6

- 230V Motor
- 20mm Base
- 4 Remotes
- Controller + Receiver
- 10m Reflective Sensor
- Booster Aerial

LOLUX230-PRO

KITS

#1,3,5

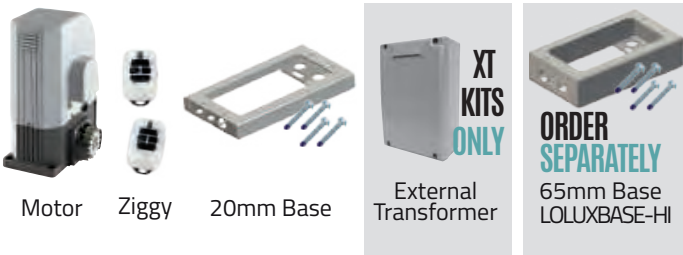

Motor Ziggy 20mm Base External Transformer XT KITS ONLY ORDER SEPARATELY 65mm Base LOLUXBASE-HI

#2,4,6



Motor Ziggy Booster Aerial External Transformer XT KITS ONLY ORDER SEPARATELY 65mm Base LOLUXBASE-HI 10m Reflective Sensor 20mm Base

		ALL METAL GEARS	
		Made in Italy	
MOTOR		24V	230V
Motor Voltage	V	24 (DC)	230 (AC)
Motor Power	W	110	450
Duty Cycle	%	30	20
Opening Per Hour	5m gate	18	11
Opening Speed	m/min	10	10
Thrust Max.	N	260	490
Manufacturers Rating	kg	800	900
Protection Degree	IP	X4	X4
Dimensions (H-W-D)	mm	320h 240w 184d	320-240-188
Motor Weight	kg	12	12.5
Working Temperature	°C	-20° to 40°	-20° + 40°
REMOTE			
Remote		4 Channel	Rolling Codes
			Rolling Codes
CONTROL BOARD			
Control Board		NET24	NET230N
Input Power	V	24(DC)	230(AC)

REV



24V

KIT#1

24V Motor
2 Remotes
Controller + Receiver

REV

KIT#2

24V Motor
4 Remotes
Controller + Receiver
10m Reflective Sensor
Booster Aerial

REV-PRO

EXTERNAL TRANSFORMER

KIT#3

24V Motor
2 Remotes
Controller + Receiver
External Transformer

REV-SP

KIT#4

24V Motor
4 Remotes
Controller + Receiver
10m Reflective Sensor
Booster Aerial
External Transformer

REV-PRO-SP

230V

KIT#5

230V Motor
2 Remotes
Controller + Receiver

REV230

KIT#6

230V Motor
4 Remotes
Controller + Receiver
10m Reflective Sensor
Booster Aerial

REV230-PRO

KITS

#1,3,5



Motor



Ziggy



External Transformer



ASK ABOUT A REV UPGRADE KIT.

TRADE FIRST BASES (ORDER SEPARATELY)

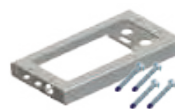

40mm Base
REVBASE-LOW



Cantilever Base
REVBASE-HI

#2,4,6



Motor



Booster Aerial



External Transformer



Ziggy



Reflective Sensor

DEA

Made in Italy

ALL METAL
GEARS

MOTOR		24V	230V
Motor Voltage	V	24 (DC)	230 (AC)
Motor Power	W	250	500
Duty Cycle	%	60	45
Opening Per Hour	8m gate	36	27
Opening Speed	m/min	15	12.5
Thrust Max.	N	450	900
Manufacturers Rating	kg	1000	1000
Protection Degree	IP	44	44
Dimensions (H-W-D)	mm	390-320-220	390-320-220
Motor Weight	kg	18	18
Working Temperature	°C	-20° + 50°	-20° + 50°
REMOTE			
Remote		4 Channel	Rolling Codes
CONTROL BOARD			
Control Board		NET24N	NET230N
Input Power	V	24(AC)	230(AC)

CHARGER



CHARGER

KIT#1

230V Motor
2 Remotes
Controller + Receiver

CHARGER230

KIT#2

230V Motor
4 Remotes
Controller + Receiver
10m Reflective Sensor
Booster Aerial

CHARGER230-PRO

KITS

#1



Motor



Ziggy



ASK ABOUT
CUSTOM KITS.

#2



Motor



Ziggy



10m
Reflective Sensor



Booster Aerial

TECH SPEC

DEA Made in Italy

MOTOR

MOTOR		CHARGER
Motor Voltage	VAC	230
Motor Power	W	560W
Duty Cycle	%	25%
Opening Per Hour	12m gate	15
Opening Speed	m/min	10
Thrust Max.	N	875
Manufacturers Rating	max. kg	1800
Protection Degree	IP	44
Dimensions (H-W-D)	mm	410-330-240
Motor Weight	kg	30
Working Temperature	°C	-20 + 50

REMOTE

Remote	4 Channel	Rolling Codes
--------	-----------	---------------



ALL METAL
GEARS

TRADE FIRST BASES (ORDER SEPARATELY)

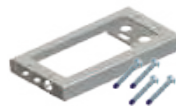

40mm Base
CHARGERBASE-LO

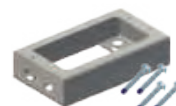

115mm Base
CHARGERBASE-HI

FIX MOTOR
TO MATCH
RACK

JUGGERNAUT



JUGGERNAUT JUNIOR

JUGGERNAUT

KIT #1

KIT #2

Motor
2 Remotes
Controller + Receiver

Motor
4 Remotes
Controller + Receiver
10m Reflective Sensor
Booster Aerial

Motor Only

JUGGERNAUTJR

JUGGERNAUTJR-PRO

JUGGERNAUT

MATCH MOTOR TO RACK

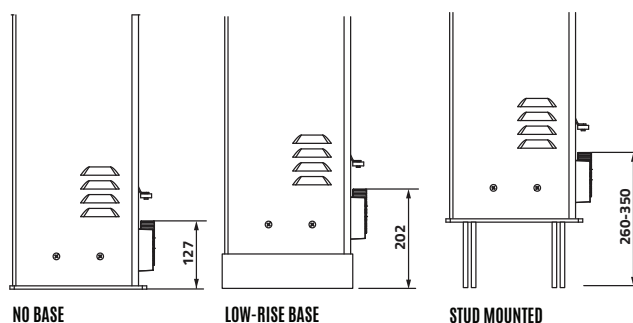

TRADE FIRST BASE (ORDER SEPARATELY)

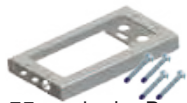

75mm Junior Base
LGBASE-LO

Made in
Italy

KITS [JUNIOR ONLY]

#1



Motor



Ziggy

#2



Motor



Ziggy



15m
Reflective
Sensor



Booster Aerial

TECH SPEC

BENINCA

MOTOR		JUGGERNAUT JNR.	JUGGERNAUT JNR.
Motor Voltage	VAC	230	415 (3-phase)
Motor Power	W	2000	1000
Duty Cycle	%	85	85
Opening per hour	12m gate	36	36
Opening Speed	m/min	7-19*	7-19*
Thrust Max.	N	2500	5000
Manufacturers Rating	max. kg	2500	4500
Protection Degree	IP	44	44
Dimensions (H-W-D)	mm	632-333-250	768-470-270
Motor Weight	kg	31	75
Working Temperature	°C	-20° + 50°	-20° + 50°

REMOTE & RECEIVER

Remote	2 Channel	Rolling Codes	Rolling Codes
Pre-Wired Receiver		2 Channel	2 Channel

RACK

Rack	M4 (std)	M6 (special)

* Effective gate weight alters max. speed

WHAT AFFECTS GATE WEIGHT?

When it comes to EGW Swing and Sliding gates are very different. The many factors below increase the effective weight of a gate. When you're matching a motor to a gate, remember each of these things adds to the gate's weight.

SLIDE GATE

Speed: The faster it goes the greater the load.

Gate Style: Cantilever & Telescopic gates are harder to get moving than a sliding gate.

Uphill: The greater the incline, the heavier it is.

Wind: Wind force against infill adds load.

Timber Infill: Can absorb water making it much heavier.

Old Hardware: If the gate isn't smooth there's extra weight.

Installation: If the track isn't straight or the motor isn't aligned perfectly. Then guess what, you've got more weight.

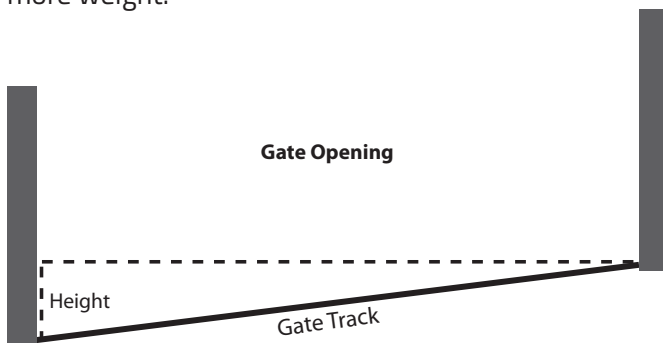

WORKSHOP TIPS

Let us work it out.

Call us with the...

- Gate length
- Gate weight
- Driveway incline (see diagram)

...and by using our Slope Calculator developed inhouse we can work out the best motor for your gate.

SWING GATE

Solid Infill: Gates with solid infill panels make the gate act like a sail and can put massive force on the motor.

Timber Pailings: Absorb water making the gate much heavier.

Hinges: Rusty or misaligned hinges without lubrication make the motor work hard.

Gate Length: Long gates have more momentum and put more strain on the hinges when compared to a high narrow gate of the same weight.

Speed: The faster you push it the more force you'll need.

Hinge Selection: Automation using linear drive motors puts a heap of force on the hinges. Welded butt hinges are a disaster waiting to happen. Tapered bearing hinges on the bottom with ball bearing top hinges are the way to go. Pintle or gudgeon type hinges are OK on lighter gates.

WEIGHT RATING

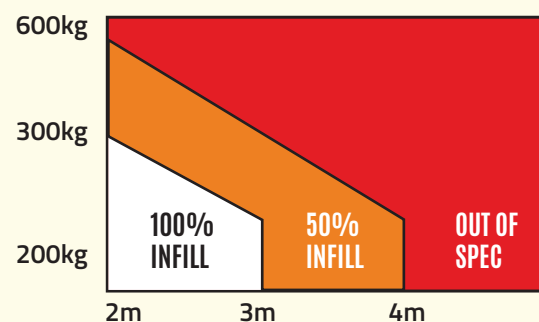

Wind loading on gates with 100% infill places extra load on the motor.

BASE SELECTOR

Lolux

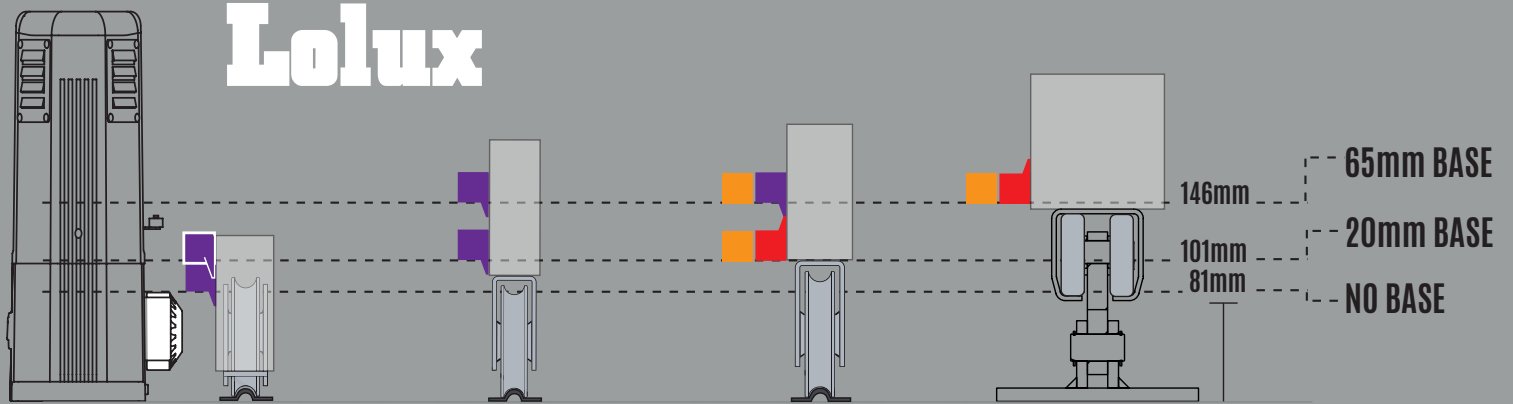

RECESSED WHEEL 90mm (300550)

Wheel Rating: 300kg
Bottom Channel: 100x50
Rack: AR-6FPNR

BOTTOM MOUNT WHEEL 80mm (327-80S)

Wheel Rating: 200kg
Bottom Channel: 100x50
Rack: AR-6FPNR

BOTTOM MOUNT WHEEL 100mm (328-100)

Wheel Rating: 400kg
Bottom Channel: 100x50
Rack: AR-6FPNR
Rack: AR-6FPNRUP
Rack: AR-STERHOL12

CANTILEVER Carriage Small (M)

Bottom Channel: 75x100
Rack: AR-6FPNRUP
Rack: AR-STERHOL12



Steel Rack



Nylon Rack



Nylon Rack Up



Workshop Tips

Make motor install faster.
A base positions the drive gear at rack height.

This quick guide matches the right wheels, rack, motor, and base to the gate.

1. Confirm Effective Gate Weight (EGW)
2. Decide on the style of wheels
3. Select a motor to match the EGW
4. Choose the base to suit the wheels

Rev

NOTE:
REV 1,400KG UPGRADE KIT
REDUCES COG HEIGHT 8MM.

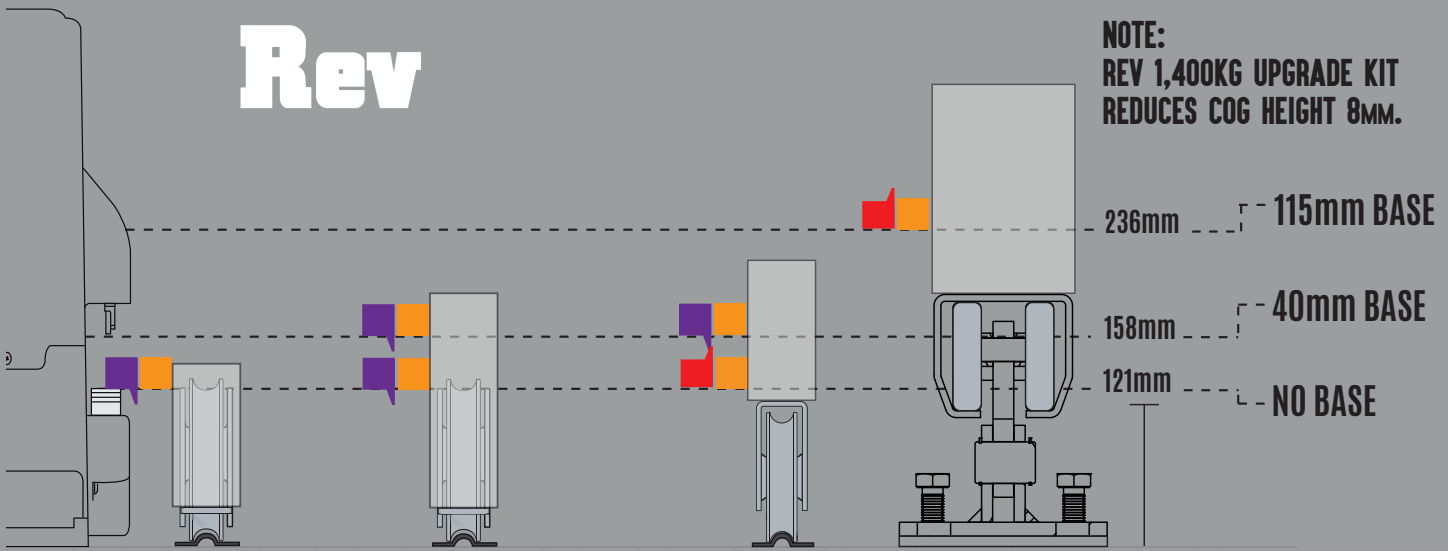

RECESSED WHEEL:
90mm (300550)

Wheel Rating: 300kg
Bottom Channel: 100x50

Rack: AR-6FPNR
Rack: AR-STERHOL12

RECESSED WHEEL:
120mm (300551H)

Wheel Rating: 400kg
Bottom Channel: 150x50

Rack: AR-6FPNR
Rack: AR-STERHOL12

BOTTOM MOUNT WHEEL:
100mm (328-100)

Wheel Rating: 400kg
Bottom Channel: 100x50

Rack: AR-6FPNR
Rack: AR-STERHOL12

CANTILEVER:
Carriage Medium (P)

Bottom Channel: 150x100

Rack: AR-STERHOL12

Charger

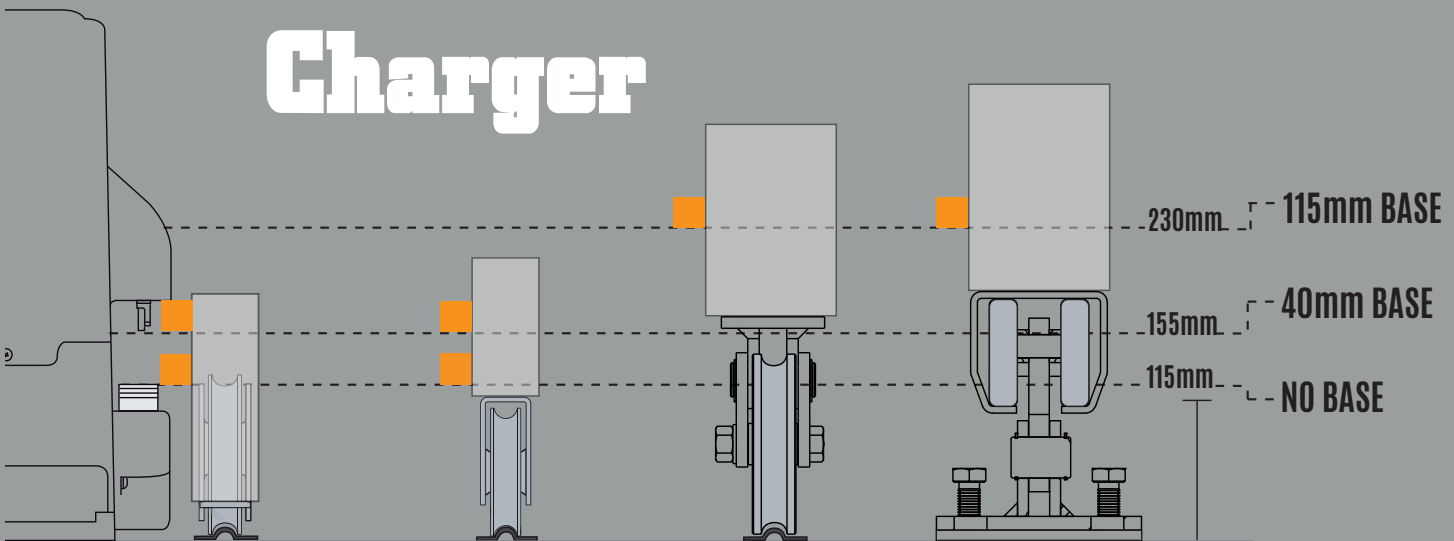

RECESSED WHEEL:
160mm (338-160)

Wheel Rating: 600kg
Bottom Channel: 150x50

Rack: AR-STERHOL12

BOTTOM MOUNT WHEEL:
100mm (328-100)

Wheel Rating: 400kg
Bottom Channel: 100x50

Rack: AR-STERHOL12

BOTTOM MOUNTED
TWIN: 120mm (339-120)

Wheel Rating: 1200kg
Bottom Channel: 150x100

Rack: AR-STERHOL12

CANTILEVER:
Carriage Medium (P)

Bottom Channel: 150x100

Rack: AR-STERHOL12

RACK

Comunello®



1M NYLON RACK WITH STEEL CORE

Code	Dimensions	Load (max.)
------	------------	-------------

AR-4FPNR	20 x 28 x 1000 with 4-fixing points	500kg
----------	-------------------------------------	-------



Code	Dimensions	Load (max.)
------	------------	-------------

AR-6FPNR	20 x 28 x 1000 with 6-fixing points	700kg
----------	-------------------------------------	-------



Code	Dimensions	Load (max.)
------	------------	-------------

AR-6FPNRUP	20 x 28 x 1000 with 6-fixing points	700kg
------------	-------------------------------------	-------



Suits Cantilever Gates

Self Threading bolt

Code	Size	Ctn	Finish	Nett Price (ctn)
M10-TRILOBE-G	M10	100	Galvanised	
M10-TRILOBE-Z	M10	100	Zinc	

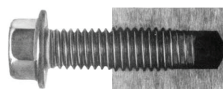

1M STEEL RACK

Code	Description
------	-------------

AR-STERHOL12	1m Bolt-On Steel rack Includes three weld-on spacers
--------------	--



Code	Description
------	-------------

AR-STER	1m Weld-On Steel rack Rated up to 2200kg max.
---------	--



Code	Description
------	-------------

AR-263	Bolt Through Spacer
--------	---------------------

AR-264	Weld on Spacer
--------	----------------



AR-263



AR-264

Code	Description
------	-------------

AR-STERBIG	2m Weld-On Steel rack M6 teeth Rated up to 4000kg max.
------------	--



Suits JUGGERNAUT

Code	Description
------	-------------

AR-OFFSETBRACKET	Weld-on offset bracket for steel rack
------------------	--





GATE MATE & GOOSENECK

Three heads, Two heights! GATE MATE

HEADS



SMALL



MEDIUM



BIG

The hinged head makes wiring easier.

Code	Description
TRUCKER-1	GATE MATE Body - Bolted, 2m
TRUCKER-2	GATE MATE Body - Concreted, 2m
SHORTIE-3	GATE MATE Body - Bolted, 1.2m
SHORTIE-4	GATE MATE Body - Concreted, 1.2m
HEAD-SML	GATE MATE Head - Small - 250h x 150w
HEAD-MED	GATE MATE Head - Medium - 200h x 350w
HEAD-BIG	GATE MATE Head - Big - 330h x 330w



BODIES



TRUCKER-1



TRUCKER-2



SHORTIE-3



SHORTIE-4

COLOUR

Gate Mate & Gooseneck come in yellow as standard.

Other colours available on request.



GOOSENECK

Accepts these access control accessories.



Code	Description
GOOSENECK-1200	1200H. Head 150x120



STING

Electromechanical automation for sliding gates
up to 3m - 400 kg



For residential and
collective usage



Available in 24V



#fastasyoulike!
STING BOOST
gate opening at 90° in 9"



STING BOOST



Quick unlocking with **customized metal key**



Get rid of ground stops by using the **mechanical stops** (optionals)

Gate opening up to **110 °**

Robust and reliable operator, in one-piece body



No risk of gate block in case of blackout thanks to the **backup batteries** (optional) that can be installed on 24V models

The DE@NET universal control units make this engine **compatible with NETLINK** System.

Very adaptable during installation, thanks to the adjustable **fixing plates** (optional - art. MLS/SFR)



Fast maneuvering with **STING BOOST**: the new 24V model of the STING range with a minimum opening time of 90 ° in 9 seconds. Available in **kit**.



STING BOOST

Opening time about 90 °

9"

Note: the opening time may increase depending on the characteristics of the installation

LOOK

24V

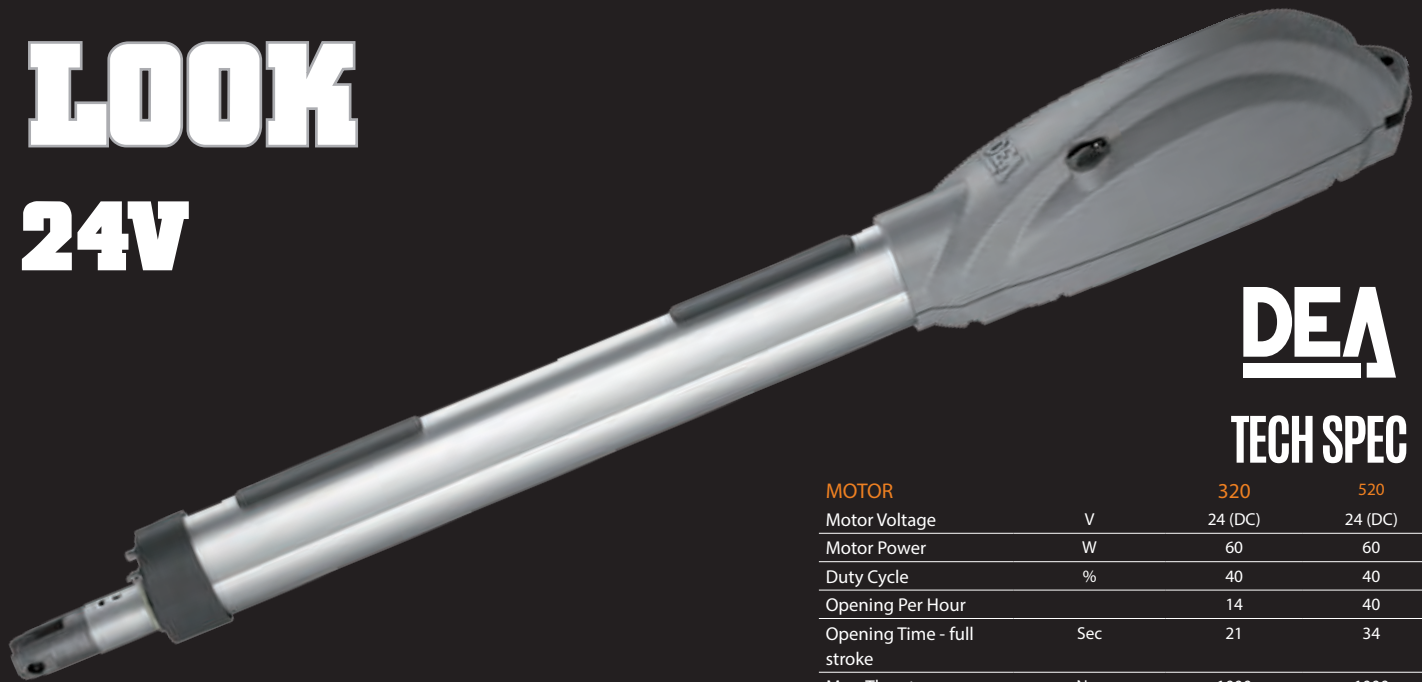

DEA

TECH SPEC

		320	520
MOTOR			
Motor Voltage	V	24 (DC)	24 (DC)
Motor Power	W	60	60
Duty Cycle	%	40	40
Opening Per Hour		14	40
Opening Time - full stroke	Sec	21	34
Max. Thrust	Nm	1000	1000
Manufacturers Rating	kg	600	600
Protection Degree	IP	24	24
Dimensions (H-W-L)	mm	120, 110, 810	120, 110, 1100
Motor Weight	kg	9	9
Working Temperature	°C	-20° + 50°	-20° + 50°
REMOTE			
Remote		4 Channel	Rolling Codes
			Rolling Codes
CONTROL BOARD			
Control Board		NET24N	NET24N

GATES TO 600KG OR 4.5M



ASK ABOUT
CUSTOM KITS.



HEAVY DUTY TRADE
FIRST MOUNT
BRACKET
AAC-LOOK-BRACKET

LOOK 320 Gates to 3m



SINGLE

Motor (24V)
2 Ziggy Remotes
Controller + Receiver

LOOK320-SINGLE

DOUBLE

2 Motors (24V)
2 Ziggy Remotes
Controller + Receiver

LOOK320-DOUBLE

LOOK 520 Gates to 4.5m



SINGLE

Motor (24V)
2 Ziggy Remotes
Controller + Receiver

LOOK520-SINGLE

DOUBLE

2 Motors (24V)
2 Ziggy Remotes
Controller + Receiver

LOOK520-DOUBLE

Limit switches available.
Can be used without limit
switches when ground
stops are installed.

LIVI 502

24V



**GATES
TO 3M /
400KG**

ARM OPTIONS



STEEL ARM
AAC-629140

ALUMINIUM ARM
AAC-629130

SLIDE ARM
2m max. gate leaf

AAC-629110 (right - shown)
AAC-629120 (left)

Flexible elbow
for rising hinges.



**RUBER RISER
SWINGER-RISER**

TECH SPEC

MOTOR	24V	
Motor Voltage	V	24 (DC)
Motor Power	W	80
Duty Cycle	%	35
Opening Per Hour		35
Opening Time to 90°	Sec	34
Max. Torque	Nm	180
Manufacturers Rating	kg	400
Protection Degree	IP	44
Dimensions (H-W-L)	mm	185, 186, 370
Motor Weight	kg	13.2
Working Temperature	°C	-20° + 50°
Max. Gate Length	m	3

REMOTE	4 Channel Rolling Codes	
Remote	4 Channel	Rolling Codes

CONTROL BOARD	NET24N	
Control Board		NET24N
Input Power	V	24(AC)

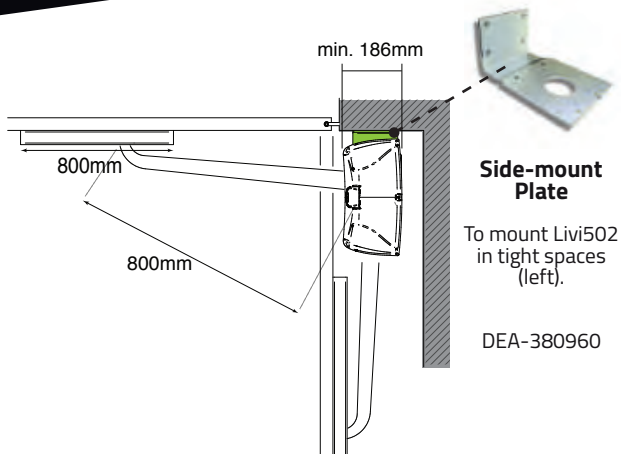

**Side-mount
Plate**

To mount Livi502
in tight spaces
(left).

DEA-380960



SINGLE

Motor
2 Ziggy Remotes
Controller + Receiver

LIVI502-SINGLE



DOUBLE

2 Motors
2 Ziggy Remotes
Controller + Receiver

LIVI502-DOUBLE

RODMAN

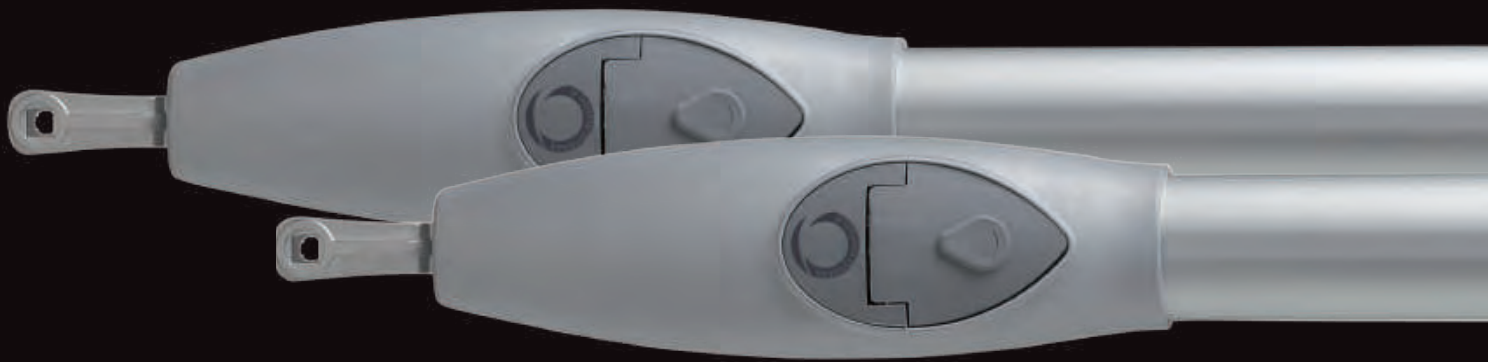

24V



KIT#1

Motor (24V)
2 SUB Remotes
Controller + Receiver
Trade First Brackets
Palm Programmer

RODMAN-1

KIT#2

Motor (24V)
4 SUB Remotes
Controller + Receiver
Trade First Brackets
Palm Programmer
2 10m Reflective Sensors
Booster Aerial

RODMAN-PRO-1

EXTERNAL TRANSFORMER

KIT#3

Motor (24V)
2 SUB Remotes
Controller + Receiver
Trade First Brackets
External Transformer
Palm Programmer

RODMAN-SP-1

KIT#4

Motor (24V)
4 SUB Remotes
Controller + Receiver
Trade First Brackets
External Transformer
Palm Programmer
2 10m Reflective Sensors
Booster Aerial

RODMAN-PRO-SP-1



KIT#5

2 Motor (24V)
2 SUB Remotes
Controller + Receiver
Trade First Brackets
Palm Programmer

RODMAN-2

KIT#6

2 Motor (24V)
4 SUB Remotes
Controller + Receiver
Trade First Brackets
Palm Programmer
2 10m Reflective Sensors
Booster Aerial

RODMAN-PRO-2

EXTERNAL TRANSFORMER

KIT#7

2 Motor (24V)
2 SUB Remotes
Controller + Receiver
Trade First Brackets
Palm Programmer
External Transformer

RODMAN-SP-2

KIT#8

2 Motor (24V)
4 SUB Remotes
Controller + Receiver
Trade First Brackets
Palm Programmer
External Transformer
2 10m Reflective Sensors
Booster Aerial

RODMAN-PRO-SP-2



DOUBLE BEARING



THREADED BRASS COLLAR

24V CONTROLLER

The world's most advanced control board uses a full-screen Palm Programmer. Detailed instructions make programming simple. Compatible with all home automation systems.





TECH SPEC

Made in Italy

		24V	230V
MOTOR			
Motor Voltage	V	24	230
Motor Power	W	120	250
Duty Cycle	%	80	30
Opening Per Hour	-	-	-
Opening time to 90°	sec	24	24
Torque	N	1300	1700
Manufacturers Rating	max. kg	600	600
Protection Degree	IP	44	44
Dimensions (H-W-D)	mm	995-108-110	995-108-110
Motor Weight	kg	9.5	9.5
Working Temperature	°C	-20 + 55	-20 + 55
REMOTE			
Remote		Rolling Codes	Rolling Codes
RX4 Receiver		4 Channel	4 Channel
CONTROL BOARD			
Control Board		14A	CT202-230
Input Power	VAC	230	230

230V



KIT#9

Motor (230V)
2 SUB Remotes
Controller + Receiver
Trade First Brackets

RODMAN230-1

KIT#10

Motor (230V)
4 SUB Remotes
Controller + Receiver
Trade First Brackets
2 10m Reflective Sensors
Booster Aerial

RODMAN230-PRO-1

230V



KIT#11

2 Motor (230V)
2 SUB Remotes
Controller + Receiver
Trade First Brackets

RODMAN230-2

KIT#12

2 Motor (230V)
4 SUB Remotes
Controller + Receiver
Trade First Brackets
2 10m Reflective Sensors
Booster Aerial

RODMAN230-PRO-2

KITS

#1,3,5,7

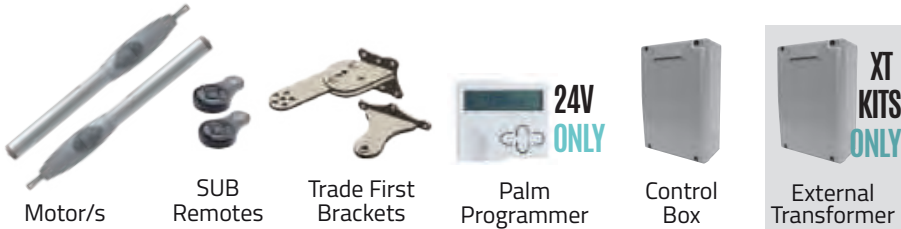

#2,4,6,8

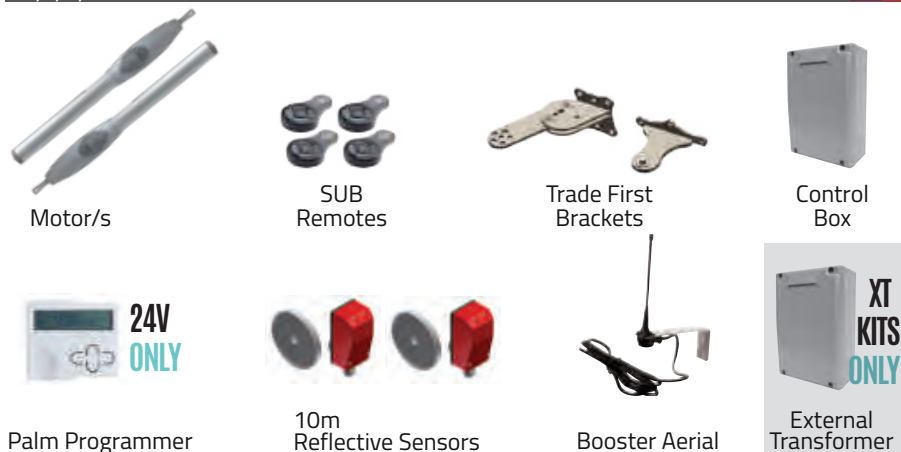

USE RISING HINGES?

MADE FOR SLOPING DRIVEWAYS.

Dea's **Swinger** and **Livi 502** will accept the optional Rubber Riser. The flexible elbow allows gates to rise upwards.



SWINGER



Arms sold separately



KIT#1-2

Motor (no arm)
2 Remotes
Controller + Receiver

- #1 SWINGER-1
- #2 SWINGER-SP-1



KIT#3-4

Motor (no arm)
4 Remotes
Controller + Receiver
2, 10m Reflective Sensors
Booster Aerial

- #3 SWINGER-PRO-1
- #4 SWINGER-PRO-SP-1



KIT#5-6

2 Motors (no arms)
2 Remotes
Controller + Receiver

- #5 SWINGER-2
- #6 SWINGER-SP-2

KIT#7-8

2 Motors (no arms)
4 Remotes
Controller + Receiver
2, 10m Reflective Sensors
Booster Aerial

- #7 SWINGER-PRO-2
- #8 SWINGER-PRO-SP-2

KITS

#1,2,5,6



Motor/s



Ziggy



External Transformer

#3,4,7,8



Motor/s



Ziggy



10m Reflective Sensors



Booster Aerial



External Transformer

Made in Italy

TECH SPEC

DEA

MOTOR	SWINGER	
Motor Voltage	VDC	24
Motor Power	W	80
Duty Cycle	%	30
Opening per hour		20
Opening Time to 90°	Sec	16
Max. Torque	Nm	180
Manufacturers Rating	kg	250
Protection Degree	IP	44
Dimensions (H-W-D)	mm	340-170-270
Motor Weight	kg	12
Working Temperature	°C	-20° + 50°
REMOTE		
Remote	4 Channel	Rolling Codes
CONTROL BOARD		
Control Board		NET24N
Input Power	V	24(AC)

SWINGER ARM OPTIONS

Swinger arms are ordered separately



Standard
SWINGER-STAND



Long Reach
SWINGER-LONG



Sliding Arm
SWINGER-SLIDE



Long Reach Steel
SWINGER-LONGS

SWINGER with SLIDING ARM

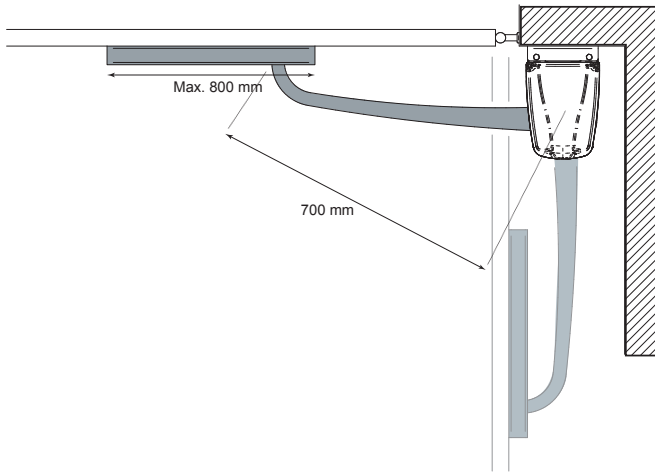

RUBBER RISER

INSTALLING RISING HINGES?

Rubber Riser fitted
to a 'Long' arm
provides a flexible
elbow to lift the
gate as it opens.



For driveway gradient
to 12%.

Max. 2m leaf, 150kg.

Swinger Riser
SWINGER-RISER

BANDITO



KIT#1-2	KIT#3-4	KIT#5-6	KIT#7-8
Motor 2 SUB Remotes Palm Programmer Controller + Receiver	Motor 4 SUB Remotes Palm Programmer Controller + Receiver 2, 10m Reflective Sensors Booster Aerial	2 Motors 2 SUB Remotes Palm Programmer Controller + Receiver	2 Motors 4 SUB Remotes Palm Programmer Controller + Receiver 2, 10m Reflective Sensors Booster Aerial
#1 BANDITO-1 #2 BANDITO-SP-1 (XT kit)	#3 BANDITO-PRO-1 #4 BANDITO-PRO-SP-1 (XT kit)	#5 BANDITO-2 #6 BANDITO-SP-2 (XT kit)	#7 BANDITO-PRO-2 #8 BANDITO-PRO-SP-2 (XT kit)

KITS

#1,2,5,6



#3,4,7,8



TECH SPEC

MOTOR		BANDITO
Motor Voltage	VDC	24
Motor Power	W	120
Duty Cycle	%	80
Opening Per Hour	-	-
Opening Time to 90°	sec	18
Torque	Nm	350
Manufacturers Rating	max. kg	400
Protection Degree	IP	43
Dimensions (L-W-H)	mm	330-187-157
Motor Weight	kg	13.8
Working Temperature	°C	-20 + 55
REMOTE & RECEIVER		
Remote		Rolling Codes
RX4 Receiver		4 Channel
CONTROL BOARD		
Control Board		14A
Input Voltage	VAC	230
Dimensions (L-D-H)	mm	222-110-175
Max. Cable Distance	mtrs	10

PRO Gate ACCESSORIES



MEMO NET

- Save DEA control board data on your PC (Transmitters & Parameters)
- Copy data onto new control boards for multiple installations.

AAC-MEMONET



PRO BOX

- A hub to expand accessories connections with dedicated input terminals
- No more confusing wiring
 - Space for additional gate accessories drivers
 - DIN rail accessories compatible
 - Easy access for maintenance and servicing

AAC-PROBOX

ACCESS CONTROL



SUB

- Water Resistant
- 8 Colours
- Connect up to 4 automation items
- Suits Key Automation
- Use with any motor, just add a Recalone.

AAC-SUB-C



ZIGGY

- Black or white
- 4 channel
- Suits DEA systems
- Use with any motor, just add Recmio

ZIGGY-4W



RECEIVERS

- To Suit DEA
- AAC-RECMIO (24v)
- AAC-RECMIO12V (12v)

• To Suit Key Automation
AAC-RECALONE



PROXIMITY KEYPADS

- Blue backlit keys (illuminated 24/7)
- Up to 1000 codes
- Card or Key Tag
- 2 channels

AAC-DIGIPRO

AAC-SWTAG

AAC-DIGISLIM

AAC-SWCARD



WIRELESS DEAPAD

- Suits DEA systems
- Batteries included

AAC-DIGIRAD



WIRELESS KEYPAD

- Suits Key Automation systems
- Batteries included
- Digital keypad with back light

AAC-KEYPAD

SAFETY



PHOTOCELLS

- Hard-wired & battery pwr
- 15m (batt.) & 20m range
- Adjustable °180
- AAC-PH20 (hardwired)

AAC-662043 (battery)



IMPACT COVERS

- Protects against damage by vandals
- Fits both photocell models (left).

DEA-681060



REFLECTIVE SENSOR

- 10m - 15m models
- Pre-wired with connector
- Relay NO/NC

AAC-PHR10

AAC-PHR15



SAFETY EDGE

- Super sensitive, the ultimate obstacle detector for sliding gates
- Covers the entire-gate edge
- Easy wireless install

EDGESHORT

EDGELONG



FLASHING LIGHT

- 24V
- 360 degrees
- Xenon strobe

AAC-FL3

ACCESS CONTROL



OPEN/CLOSE CONTROL

- Pre-wired with 1m lead
- IP65 enclosure
- Easy to install

AAC-PUSHB



DIGITAL TIMER

- Keep a gate open for customised set periods
- 7 day, 24 hour timer
- Mains power

AAC-DIGITALTIMER



VEHICLE DETECTOR

- 10 sensitivity settings
- Optimum sensitivity setting
- Lighting & surge protection
- Two sizes: 1.2x2.4m & 1.8x3.6m

AAC-LOOP AAC-LOOPBIG



EXIT SENSOR

- Installed with new or existing drive ways
- Pre-wired 15m lead-in cable
- Easy to install

AAC-PROBE



BOOSTER AERIAL

- Extend a remote's range up to 50m
- Pre-wired with connector

AAC-ANT433

SECURITY



VERTICAL ELECTRIC LOCK

- Suitable for inside or outside manual or automatic doors
- Pedestrian or drive-through gates

AAC-PLA10

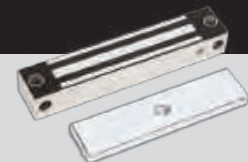

MAGNETIC LOCK

- 200kg lock strength
- 24V Power Supply
- Supplied with all power components

AAC-MGL-AC (suits Key, Bennisca, Mhouse)

AAC-MGL-DC (suits DEA)



HORIZONTAL ELECTRIC LOCK

- Suitable for inside or outside manual or automatic doors
- Pedestrian or drive-through gates

AAC-PLA11



CISA LOCK

- Rotary hook deadbolt in extruded aluminium
- Metal striker with stainless steel "swinging rod"
- Operation from outside with a key or from inside with a push-button or a key

AAC-CISALOCK

POWER



30W SOLAR KIT

- 230V battery charger
- 2-piece battery box. Incl. quick-release battery saddle to carry batteries to charger.
- Plug-in cables
- 17Ah battery (x2)

AAC-SUN30



BACK-UP BATTERY

- Back up battery for 24V automation systems

DEA

KEY AUTOMATION

AAC-BB24-DEA

AAC-BB24-14ALL



SCLAK

Sclak lets you to open any kind of gate motor (or elec. lock) with a smartphone. Uses a Bluetooth LE 4.0 signal. No internet connection needed.

BOOM GATE

MADE IN ITALY

4m

24V Boom Motor
Big LED warning light both sides
4m Boom
Boom Connector
Mount Base

ABG-BOOM4

6m

24V Boom Motor
Big LED warning light both sides
6m Boom
Boom Connector
Mount Base

ABG-BOOM6

8.5m

24V Boom Motor
Big LED warning light both sides
8.5m Boom
Boom Connector
Mount Base

ABG-BOOM8



REPLACEMENT BOOM - ALUMINIUM



Code	Type
ABG-AST4	4m Boom
ABG-AST6	6m Boom
ABG-AST8	8.5m Telescopic Boom

OPTIONAL



Freestanding Boom Support
ABG-APF



Hinged Boom Support
ABG-APM



FEATURES

- One touch programming
- Ability to change open vs closing speeds
- Built-in led flashing light both sides
- Double spring (6m model) to counter balance movement
- Robust gears and levers for reliable functioning over time
- Energy saving mode
- Universal box: Bar can be installed both right or left

TECH SPEC

BOOM GATE	4m	6m	8.5m
Motor Voltage	24	24	24
Motor Power	-	-	-
Duty Cycle	% 80	80	80
Opening Per Hour	-	-	-
Opening time to 90°	3.5	6	6
Torque	200	250	250
Protection Degree	IP 54	54	54
Dimensions (H-W-D)	mm 360 - 220 - 1110	450 - 280 - 1188	450 - 280 - 1188
Weight	kg 47	67	67
Working Temperature	°C -20 + 55	-20 + 55	-20 + 55

CONTROL BOARD

Control Board	CT102 24	CT102 24	CT102 24
Input Power	VAC 230	230	230



MOTOSHAFT

SHUTTER DOOR MOTORISED DRUM

INSTALLATION VIDEOS

See the Motoshaft install, wiring, set-up and adjustments videos on the Downee YouTube channel.

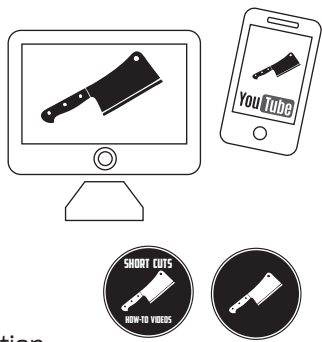

- Complete Install
- Wiring
- Shutter open & close position.
- Travel time.
- Deadman mode
- 24V & 230V

TAILOR-MADE FOR COMMERCIAL & SMALL INDUSTRIAL DOORS.

BENEFITS

- Safe: No coil spring to tension on site
- Fast & easy install
- No electrician: Pre-wired 3-pin plug
- Plug-n-Play
- ACMA certified
- Brake release cable in case of power failure

APPLICATION

- Shop fronts, store rooms, counters and kiosks
- Good Lifts
- Small industrial doors
- Max. shutter specs:
Weight: 350kg
Height: 5.5m
Width: 7.5m

COMPATIBLE DOORS

- Aluminium Shutters
- Poly Shutters
- Light Steel Shutters



SUPERLIGHT! MOST MOTOSHAFT ARE LIFTED BY TWO GUYS.



Motoshaft uses 24V or 230V motors with constant force springs on a custom length shaft.

They're fast and easy to install.

Send us the shutter curtain size and our engineers will spec the shaft system, ready to be bolted into place.

Motoshaft uses a 24V or 230V central motor, constant force springs mounted on shaft cut-to-size.

230V motors are used in low-frequency shutters. (30% duty cycle)
24V Motoshaft is for the busy shutters (70% duty cycle)

LENGTH	WEIGHT
1.5m-3m	20-25kg
3m-4m	25-30kg
4m-5m	40-50kg
5m-7m	50-80kg

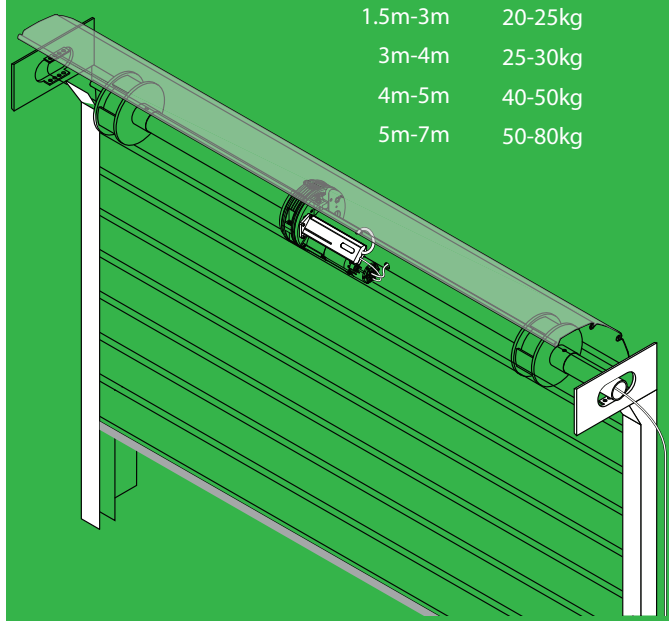



CUSTOM-MADE AUTOMATION HARDWARE

Trade First products make installation quicker, easier and improve overall performance of a gate system.

Trade First products are designed and made by Downee.

SLIDE MOTOR BASES

Trade First bases are designed to place the motor to the rack on all gates styles; slide & cantilever

Use the easy Base Selector to get the best match.

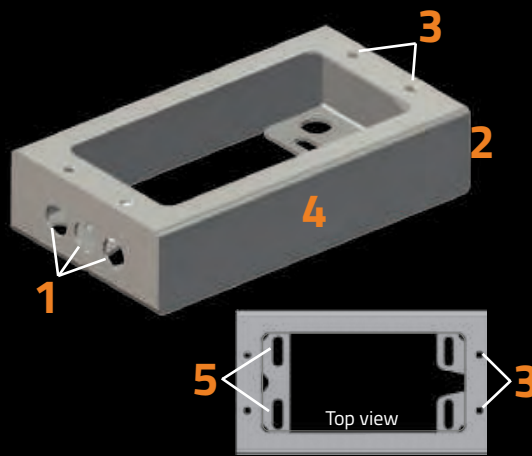

- 1 Cable entry holes
- 2 Matches motor height to gate frame & wheels
- 3 Pre-drilled holes for the motor base
- 4 Hot dip gal finish
- 5 Slotted holes to align motor to rack
- 6 No ChemSet = less trips to site

SLAB

For Residential Cantilever Gates. Fast, easy install & perfect gate-to-wheel alignment every time



- 1 Pre-drilled holes for the motor base
- 2 Wheels bolt directly onto threaded rods
- 3 Guide post sleeve mounts left or right
- 4 No ChemSet needed

Wheels and motor sold separately.

SWING MOTOR BRACKETS

Quick & Easy adjustment

- 1 Adjusts A & B distances
- 2 Room for a drill
- Tough 10mm steel construction & hot dip gal finish
- Fits to 100 SHS post & 40mm cross rail
- No welding. Mount with Tek screws

SUITS RODMAN & LOOK



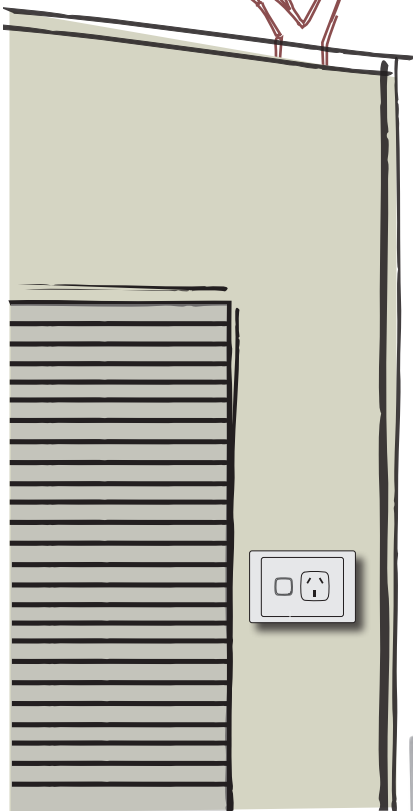
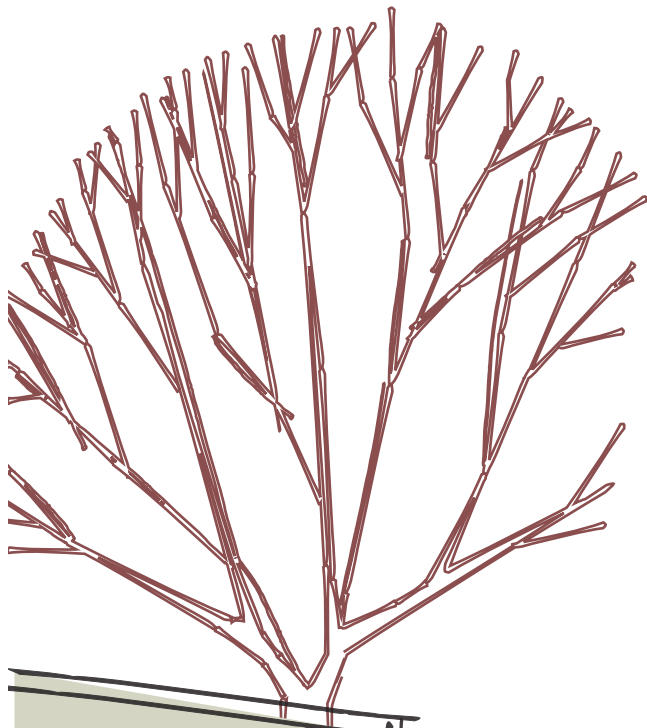

Any powerpoint in a garage, home or garden.



3-pin cable (1m) pre-wired



External Transformer

24V cable up to 50m (Not supplied)

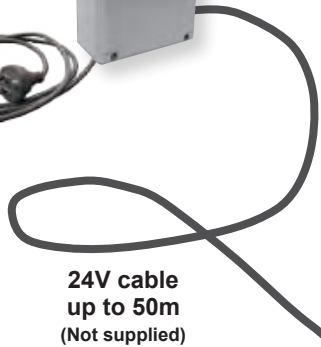

Control Box (for swing gates only)



EXTERNAL TRANSFORMER (remote 24v power supply)

Not every gate has 230V available. And digging a 600mm deep trench for 230V cable is expensive. Here's the alternative.

All 24V automation by Downee can be ordered with an External Transformer option.

The external transformer has a 3-pin plug pre-wired to plug straight into a power point inside or near the house. This lets you run 24V garden cable to the control box at the gate.

- Makes all the install electrical work 24V
- Removes the need for 230V power point at the gate
- Suits all 24V automation

NiceHome,
the next
generation
mhouse.



Your
Smart
Nice Home

mhouse
compatible

Maestro 200

Complete articulated arm kit for automating two-leaf swing gates up to 2.2 m wide and weighing up to 250 kg per leaf.

Kit Code

MAESTRO200 Two motors, two remotes (double gate kit)

Fast

8 seconds* to open or close the gate.

Simple

Complete kit ready for installation, connection of accessories with just 2 wires (Bus technology).

Safe

Optional photocells to protect pedestrians and vehicles during the gate operation.

Strongly recommended.

Flexible

Articulated arm operators provide precision and respect for the structure of your gate, thanks to the natural opening action.

Environmentally-friendly

Compatible with the Solar Kit solar power kit and wireless accessories lines.

The kit contains



Power accessories



*For 90° opening, without acceleration and deceleration.

Optional accessories



Safety photocells, to protect pedestrians and vehicles from automatic gates. **PH200**



Wireless keypad 13 keys to manage up to 3 automations. Battery-powered. **DS100**



24v receiver to operate garage doors, lighting and watering systems up to 500w, via ECCO remotes. **R200**



230v universal receiver to control other brand automations. **RC200**



Lock Operator Used with an electric lock. **EL100**

Alto 100

Complete articulated arm kit for automating single swing gates up to 1.6 m wide and weighing up to 100 kg each.

Recommended for small posts and pedestrian gates.



*For 90° opening and a weight of 50 kg, without acceleration and deceleration.

Kit code

ALTO-1 One motor, two remotes

Fast

7 seconds* to open or close the gate.

Simple

Kit ready for installation, connection of accessories with just 2 wires (Bus technology).

Compact

Ideal for small posts from 80mm.

Versatile

The arm can be cut to allow Alto to open into a space of 12 to 34 cm thanks to the unique arm design.

Environmentally-friendly

Compatible with the Solar Kit solar power and wireless accessories.

The kit contains



Power accessories



Optional accessories



Safety photocells, to protect pedestrians and vehicles from automatic gates. **PH200**



Wireless keypad 13 keys to manage up to 3 automations. Battery-powered. **DS100**



24v receiver to operate garage doors, lighting and watering systems up to 500w, via ECCO remotes. **R200**



230v universal receiver to control other brand automations. **RC200**



Lock Operator Used with an electric lock. **EL100**



Aria 200 | Aria 400

Complete worm-drive motor kit to automate two-leaf swing gates.

ARIA200 up to 2.2 m wide and weighing up to 250 kg per leaf.

ARIA400 up to 4.5 m wide and weighing up to 450 kg per leaf.

Recommended for heavy gates.

Fast and Safe

14 seconds* (ARIA200) to open or close the gate. Optional buffer battery to control the gate during blackout. Mechanical opening and closing limit stops.

Simple

Simplified installation and connection thanks to the Bus technology, prewired motors and new adjustable fixing.

Practical

The external motor release located on top of the motor itself enables the gate to be opened rapidly during blackout.

Adaptable

Allows automation of gates with an extension of up to 25cm.

Environmentally-friendly

Automations compatible with the Solar Kit solar power and wireless accessories line.

The standard kit contains



Power options



*For 90° opening, without acceleration and deceleration.

Optional accessories

-  **Safety photocells**, to protect pedestrians and vehicles from automatic gates. PH200
-  **Wireless keypad** 13 keys to manage up to 3 automations. Battery-powered. DS100
-  **24v receiver** to operate garage doors, lighting and watering systems up to 500w, via ECCO remotes. R200
-  **230v universal receiver** to control other brand automations. RC200
-  **Lock Operator** Used with an electric lock. EL100
-  **Back-up battery** insurance in case of power failure. PR100



Aria kits

ARIA 200

Double motors

ARIA200-2 Two motors, two remotes

ARIA200-SP2 Two motors, two remotes, external transformer

ARIA200-PRO2 Two motors, two remotes, pair photocells

ARIA200-PRO-SP2 Two motors, two remotes, pair photocells, external

ARIA 400

Single motor

ARIA400-1 One motor, two remotes

ARIA400-SP1 One motor, two remotes, external transformer

ARIA400-PRO1 One motor, two remotes, pair photocells

ARIA400-PRO-SP1 One motor, two remotes, pair photocells, external transformer

Double motor

ARIA400-2 Two motors, two remotes

ARIA400-SP2 Two motors, two remotes, external transformer

ARIA400-PRO2 Two motors, two remotes, pair photocells

ARIA400-PRO-SP2 Two motors, two remotes, pair photocells, external transformer

mhouse
compatible

To learn more about the controller functions visit
easygate.com.au



Controller for ARIA & MAESTRO swing motors

Aria and Maestro swing motors include an upgraded version of the original Mhouse control board with the same programming.

Compare



Programming

Programming remains the same from original for a seamless introduction to new motors.

Updates

Minor changes have been made to terminals.



- Terminals colours changed to grey.
- Electric lock function moved to SbS. Flash now only for flashing light.
- Name changes. ECSbus is now BUS. OPEN now SbS. Functions unchanged.

Overview

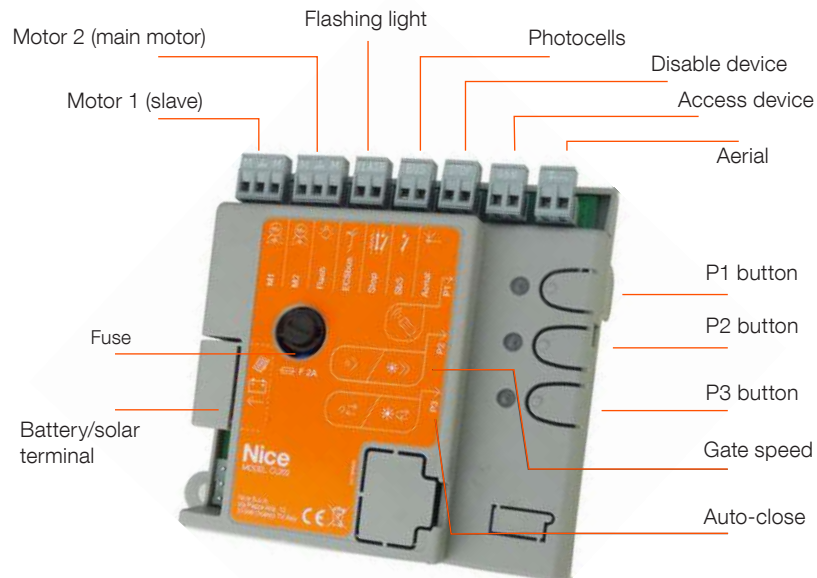

Sales and tech support and materials

Mhouse & NiceHome installers are well supported by comprehensive online resources and Downee's support technology.

For technical assistance:

techsupport@downee.com.au

Install & end-user manuals

Manuals for all products are available to download on NiceHome's Australian website: easygate.com.au

For customer support:

- VIC & TAS: 9300 5160
- NSW & ACT: 8785 5800
- WA: 9241 7300
- SA & NT: 8349 7339
- QLD: 3434 3400
- NZ: 2777 0040

The Downee Service team is on hand to help you choose the most suitable automation, answer your technical questions and provide you with additional documentation.



A collection of NiceHome programming and installation videos are available on Downee's YouTube channel or the NiceHome website easygate.com.au

Detailed install videos for professional installers plus helpful videos for homeowners to assist them complete basic tasks to keep their gate working perfectly.

Videos include:

- Connecting a remote
- Disconnecting a remote
- Setting gate open-close limits
- Change PIN codes for a keypad

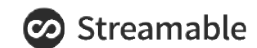

A new service introduced to instantly assist installers troubleshooting when they're onsite.

Streamable lets the installer capture the technical issue on video, then deliver it instantly to our tech support team for immediate assessment and fault finding.

QR Codes

We've introduced QR Codes as a quick way to open targeted info on a phone.

1. Open your phone's camera.
2. Focus on the QR code for 2-3 seconds.
3. Tap on the notification to open the video.

Programming and install videos are at: easygate.com.au



Try it now!

Filo 400 | Filo 600

Complete kit to automate sliding gates.

Filo 400 up to 5.5 m long and weighing up to 400 kg.

Filo 600 up to 7 m long or weighing up to 600 kg.

Faster

Filo 400 11 seconds* to open a 3m gate.

Filo 600 16 seconds* to open a 3m gate.

Safe and convenient

The new OGI (open gate indicator) function provides a power supply for 24v light, providing a nighttime alert the gate is activated. Or act as a garden light operated by the remote control.

Precise

Mechanical limit stops adjusted by cam brackets.

Flexible

Possibility of adding an LED light and light up to 500w to illuminate area surrounding the gate.

Environmentally-friendly

Automation compatible with the Solar Kit solar power and wireless accessories line.

The standard kit contains



Power options



*Without acceleration and deceleration.

Optional accessories



Safety photocells, to protect pedestrians and vehicles from automatic gates. **PH200**



Wireless keypad 13 keys to manage up to 3 automations. Battery-powered. **DS100**



24v receiver to operate garage doors, lighting and watering systems up to 500w, via ECCO remotes. **R200**



230v universal receiver to control other brand automations. **RC200**



Back-up battery insurance in case of power failure. **PR100**

Filo kits

FILO 400

FILO400 One motor, two remotes

FILO400-SP One motor, two remotes, external transformer

FILO400-PRO One motor, two remotes, pair photocells

FILO400-PRO-SP One motor, two remotes, pair photocells, external transformer

FILO 600

FILO600 One motor, two remotes

FILO600-SP One motor, two remotes, external transformer

FILO600-PRO One motor, two remotes, pair photocells

FILO600-PRO-SP One motor, two remotes, pair photocells, external transformer

To learn more about the controller functions visit
easygate.com.au

Controller for FILO slide motor

The new generation NiceHome slide motors include an updated control board featuring some minor changes.

Programming

Programming remains the same from original for a seamless introduction to new motors.

Updates

This quick view highlights the main physical changes to the new Filo controller and how they relate to the original controller.

1. Aerial terminal moved
2. P1 button is moved to L4 button
3. Yellow open button is now SbS L1-button
4. Gate direction jumpers now a switch
5. L1 to L4 LED for programming
6. SbS terminal for access control acces
7. OGI terminal for 24v light (4w)
8. LED for terminals

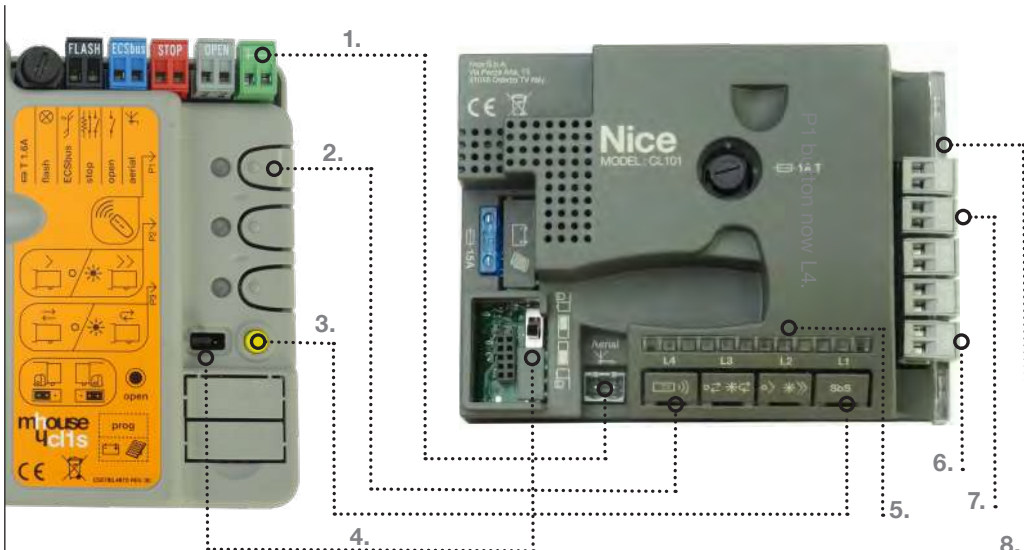

Updates (continued)

Controller now sits on top for easier access.



Selecting the gate's open direction with a switch.



Overview

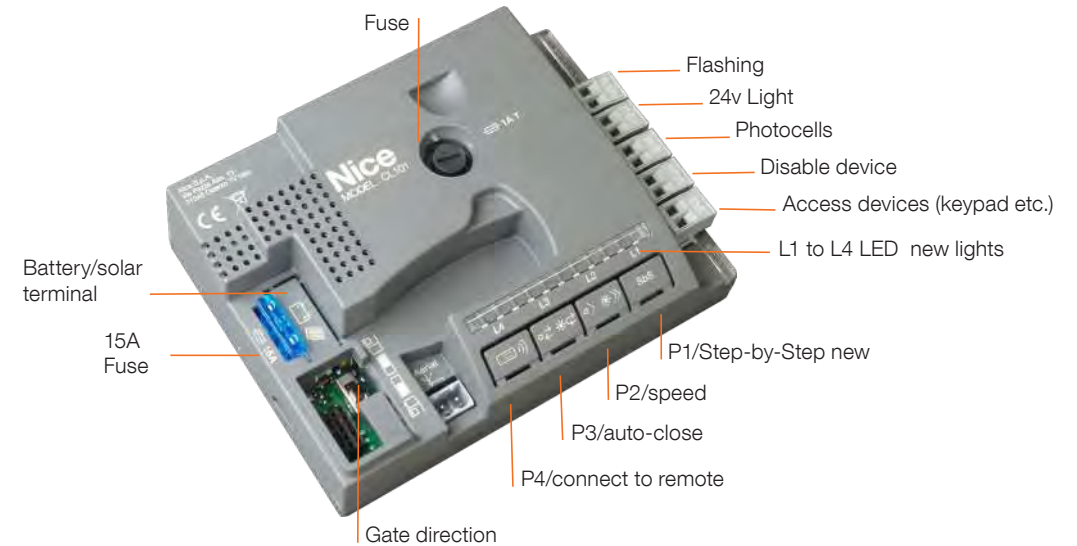

Replacement guide.

Mhouse to NiceHome.

NiceHome is a new generation of Mhouse and maintains many similarities. The high level of compatibility between the two ranges makes for an easy conversation with your customers when they ask for their favourite Mhouse motor.

This guide places NiceHome products besides the equal Mhouse item, along with some important points to answer your customer's questions.

Slide gate



Mhouse



SL1

5m long or 400kg max

NiceHome



FILO 400

5.5m or 400kg max

FILO 400 Updates

- 500mm longer gate capacity
- 20% faster
- 20% higher duty cycle
- 20min longer continuous use
- 1.5kg lighter
- Changed mounting bolt position
- New controller (see video below)

Note

- Programing vid's @ easygate.com.au
- Compatible with Mhouse accessories.



SL10

7m long or 550kg max



FILO 600

7m or 600kg max

FILO 600 Updates

- 50kg more gate weight rating
- 11% faster
- 8min. longer continuous use
- 1kg lighter
- 10% higher max. ambient temp.
- Changed mounting bolt position
- New controller (see video below)

Note

- Programing vid's @ easygate.com.au
- Compatible with Mhouse accessories.

Swing gate



Mhouse



WG2

2m or 250kg max per leaf

NiceHome



ARIA 200

2.2m or 250kg max per leaf

ARIA 200 Updates

- 200mm longer gate
- 1kg lighter
- New easier mount brackets
- Compatible with original accessories.

Note

- Minor update to controller (see video below)
- Controller and programming are same as Mhouse.



WG10 / WG20

4.5m or 450kg max per leaf



ARIA 400

4.5m or 450kg max per leaf

ARIA 400 Updates

- 5kg lighter motor
- New easier mount brackets
- Compatible with original accessories.

Note

- Controller and programming are same as Mhouse.



WS200S

2.2m or 250kg max per leaf
(discontinued 2018)



MAESTRO 200

2.2m or 250kg max per leaf

Technical materials online

Find technical assistance and support videos and manuals online:
easygate.com.au



Access control accessories

All Mhouse accessories are interchangeable with NiceHome. And new NiceHome accessories are compatible with Mhouse.



GTX4 REMOTE
AAC-GTX4



ECCO REMOTE
AAC-ECCO

ECCO Updates

- Dedicated 5th button for lighting



WIRELESS KEYPAD
AAC-DS1



WIRELESS KEYPAD
AAC-DS100



PHOTOCELLS
AAC-PH1



PHOTOCELLS
AAC-PH200



24v RECEIVER
AAC-R2



24v RECEIVER
AAC-R200



230v RECEIVER
AAC-RC2



230v RECEIVER
AAC-RC200



ELECTRIC LOCK OPERATOR
AAC-EL1



ELECTRIC LOCK OPERATOR
AAC-EL100

Power accessories



SOLAR POWER KIT
AAC- SUN



SOLAR POWER KIT
AAC- SOLARKIT



BACK-UP BATTERY
AAC-PR1



BACK-UP BATTERY (suits Filo & Aria)
AAC-PR100



BACK-UP BATTERY
AAC-PR3



BACK-UP BATTERY (Maestro 200)
AAC-PR300

Discontinued

No equivalent products available in the NiceHome range.



OBSTACLE SENSORS
AAC-PT50 (485mm high)
AAC-PT100 (985mm high)



WARNING LIGHT
AAC-FL1



UNDERGROUND MOTOR WU200S
(discontinued 2018)



KEY SWITCH
AAC-KS100

SLIDING GATE HARDWARE

Workshop Tips

How are wheel ratings worked out?

A 200kg gate needs two wheels each rated more than 100kg.

Tip: Never use three wheels on a gate!

Bolt Down Track, 20mm Wheel - Galvanised



Code	size	Bundle
SGT3	3000 x 3 mm	20
SGT4	4000 x 3 mm	20
SGT6	6000 x 3 mm	20

Stainless steel

Code	size
SGT3SS	3000 X 3 mm

Concrete-in Track, 20mm Wheel - Galvanised



Code	size	Bundle
287/20CT	3m x 3mm	10
287/20CT-6	6m x 3 mm	10
287G19	3m x 4mm	54

Recess Kit for 287G19 Track



Code	Suits
287FP-G	287G19

• To be used with 287G19

Track Joiners



Code	Diameter
287/20-JOINER	14mm
287G19-JOINER	11mm

Radial Damper: One-way speed damper.

Code	Rating
SMC	1250kg
SMC-HD	2180kg



The ultimate safety device for gates on an incline.

- Controls runaway gates.
- Simple to install.
- Zero maintenance.

Parrot Beak Lock Kit



Code	Frame Size	Ctn
PBL40KIT	suit 40x40 mm	5
PBL50KIT	suit 50x50 mm	5



Recessed Gate Wheel - 20mm track



Code	Rating	D
337-80S	180kg	80 Ø
300550	300kg	90 Ø
300550HC	300kg	90 Ø High Clearance
430/100	380kg	100 Ø
300551H	400kg	120 Ø
338-160	600kg	160 Ø

Wheels for Ø 16mm Track

Code	Rating	D
337-90	190kg	90 Ø

Wheels for V Track

Code	Rating	D
336-90	300kg	90 Ø



Wheels for Ø 20mm Track - Stainless Steel

Code	Rating	D
300550SS	300kg	90 Ø

Bolt Through Gate Wheel



Code	Rating	D
310-100S	220kg	100 Ø
300551	450kg	120 Ø
300552	575kg	160 Ø
300553	625kg	200 Ø

Bottom Mount Gate Wheel - 20mm track



Code	Rating	D
327-80S	200kg	80 Ø
328-100	400kg	100 Ø

Heavy Duty Double Wheel



Code	Rating	D
339-120	1200kg	117 Ø

• 4 Ball bearing each set

SLIDING GATE

Top Guide



Code	Frame Size	Ctn
CG-9728	40-75	ea

Code	Frame Size	Ctn
CG-9728-140	40-60	ea

Guide Rollers



Code	W x L	Ctn
300557	37x36mm	20



Code	W x L	Ctn
23030	30x40mm	20
300558	40x60mm	20



Stainless Steel Thread and Nut with non-marking roller

Code	Size	Ctn
230-50NM	Ø50x40	20



Ball Bearing Guide with Nylon Roller

Code	Size	Ctn
246-30	30mm	20



Code	Size	Ctn
114-40	40mm	10
118-60	60mm	4

Features two sealed bearings with stainless steel cases



Code	W x L
253-40SP	40x140mm
119-40	40x250mm

Side Mount Guide Roller



Code	W x L	Ctn
253-40	40x224mm	3



Code	Size
256-40	75x40mm

Single Roller Guide



Code	Size	Ctn
CG-252	40x57mm	2

Sliding Gate Guide Roller Bracket

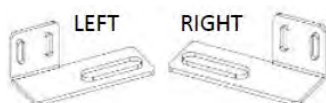

Code	Suit	Ctn
SGBR	Right	10
SGBL	Left	10

SLIDING GATE

Side Bearing Guide



Code	To suit	Ctn
CG-9764	40mm angle support	2

• Uses rollers 246.30

Top Guides



Code	Frame Size	Ctn
25530	35-62	ea
25530BB	35-52	ea

• Roller size 30x40



Code	Frame Size	Ctn
CG-251	70-110	ea

• Roller size 40x60

Slide Guide

Code	Travel	Colour
SLIDEGUIDE	280mm	All black



NOTE
• Black anodized slide channel
• Black guide block

Guide Block - white - with angle slide plates



Code	To suit	Ctn
NYBL75	75mm post	ea
NYBL100	100mm post	ea

Stops



Code	Type
300507	Weld on stop
300507B	Bolt on stop



Code	Type
202F-A	Hydraulic stop

Sliding Gate Catch



Code	Gate frame	Ctn
SGC-50	50mm	ea
SGC-75	75mm	ea
SGC-100	100mm	ea

Adjustable Angle Bracket

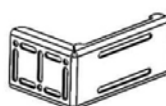

Code	Suit
SGC-AAB	Use with SGC-50, SGC-75, SGC-100

GUARDIAN CANTILEVER

GATES TO 12m



MADE IN ITALY

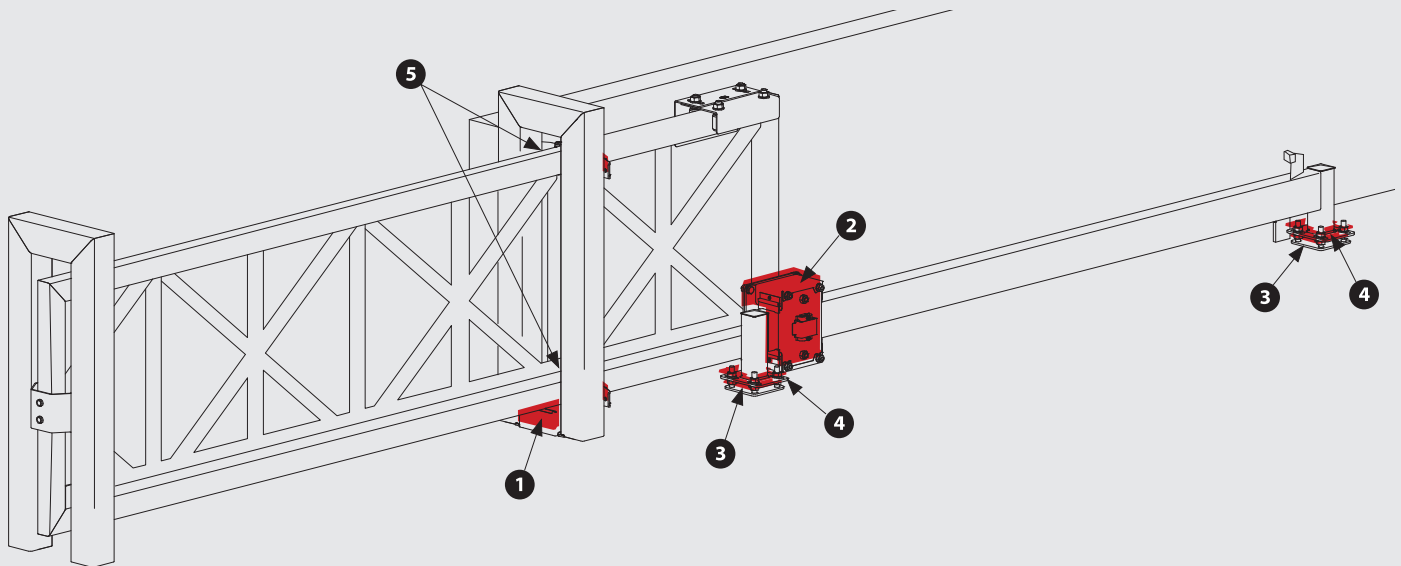

GUARDIAN GATE PACK

GAR-150-FULL



1 Base Roller Assembly



2 Tail Roller Assembly



3 4 Tail Adjuster Plates



3 4 Tail Mount Plates



5 Adjustable Guide Rollers

CANTILEVER HARDWARE

 **Comunello**

MADE IN ITALY

CANTILEVER WHEELS PRO-RANGE



5 Wheel Carriages up to 2000kg

Code	Type
CGS-350M	small
CGS-350P	medium
CGS-350G	large

NOTE: SLAB uses Residential Cantilever Kit CGS-150KIT.
See Residential Cantilever page.



8 Wheel Carriages up to 4000kg

Code	Type
CGS-350.8M	small
CGS-350.8P	medium
CGS-350.8G	large

Hard Plate



Code	Type
CG-05P	medium
CG-05G	large

Cantilever Track



Code	Type	Length	Width	KG
CGS-345M	small	3m	68	18.5
CGS-345M-6	small	6m	68	36.5
CGS-345P	medium	3m	100	35
CGS-345P-6	medium	6m	100	7
CGS-345G	large	3m	140	67
CGS-345G-6	large	6m	140	134

Adjustable End Bracket



Code	Width
CG-30M	53-76mm
CG-30P	86-114mm
CG-30G	103-150mm

Adjustable Angle Bracket for End Cup

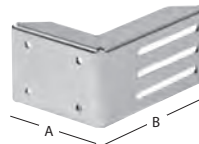

Code	A	B
CG-15M	155	165
CG-15P	155	190
CG-15G	155	220

End Cup



Code	Type
CGS-346M	small
CGS-346SCM	small, self centering
CGS-346P	medium
CGS-346G	large

End Wheels



Code	Type
CGS-347M	small
CGS-347P	medium
CGS-347G	large

Adjustable Tension Bar



Code	Suits
CGI-40	65mm SHS

SLAB



Slab makes cantilever installs easier, by reducing install time and number of visits to site.

Drop a Slab in wet concrete, level it off, then come back and complete installation of hardware and gate.

SLAB For 3 & 4m Gates

Code	Suits
SLAB-J	4m/100kg or 3m/150kg
SLAB-R	4m/150kg or 3m/200kg

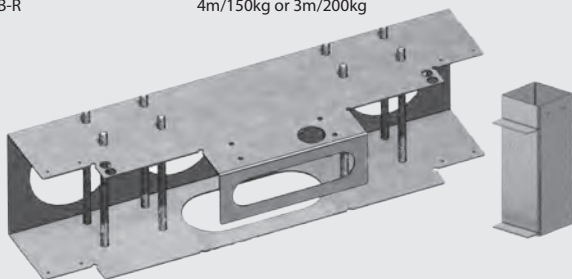

Suits left/right gates.
Cable holes under motor position.

NOTE: Bolt pattern suits Residential Hardware Kit (right).

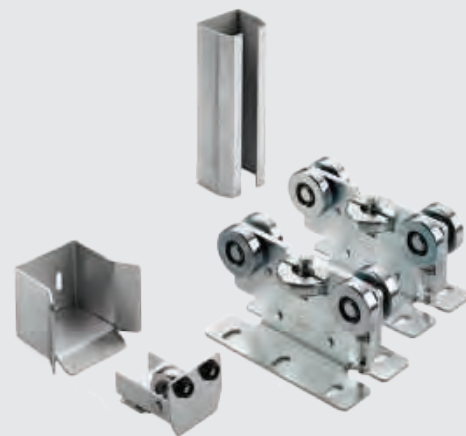

RESIDENTIAL HARDWARE KIT

Code	Description
CGS-150KIT-3	2x 3m Monorail 2x 5-wheel carriages 1x end cup 1x end wheel 4x rollers 30mm
CGS-150KIT-6	1x 6m Monorail 2x 5-wheel carriages 1x end cup 1x end wheel 4x rollers
Optional Code	Description
CG-9728	Top guide with bearing rollers
CG-9764	Side guide with bearing rollers
SLIDEGUIDE	Slide Guide

RESIDENTIAL CANTILEVER

SLAB suits
« 3 to 4m gates »

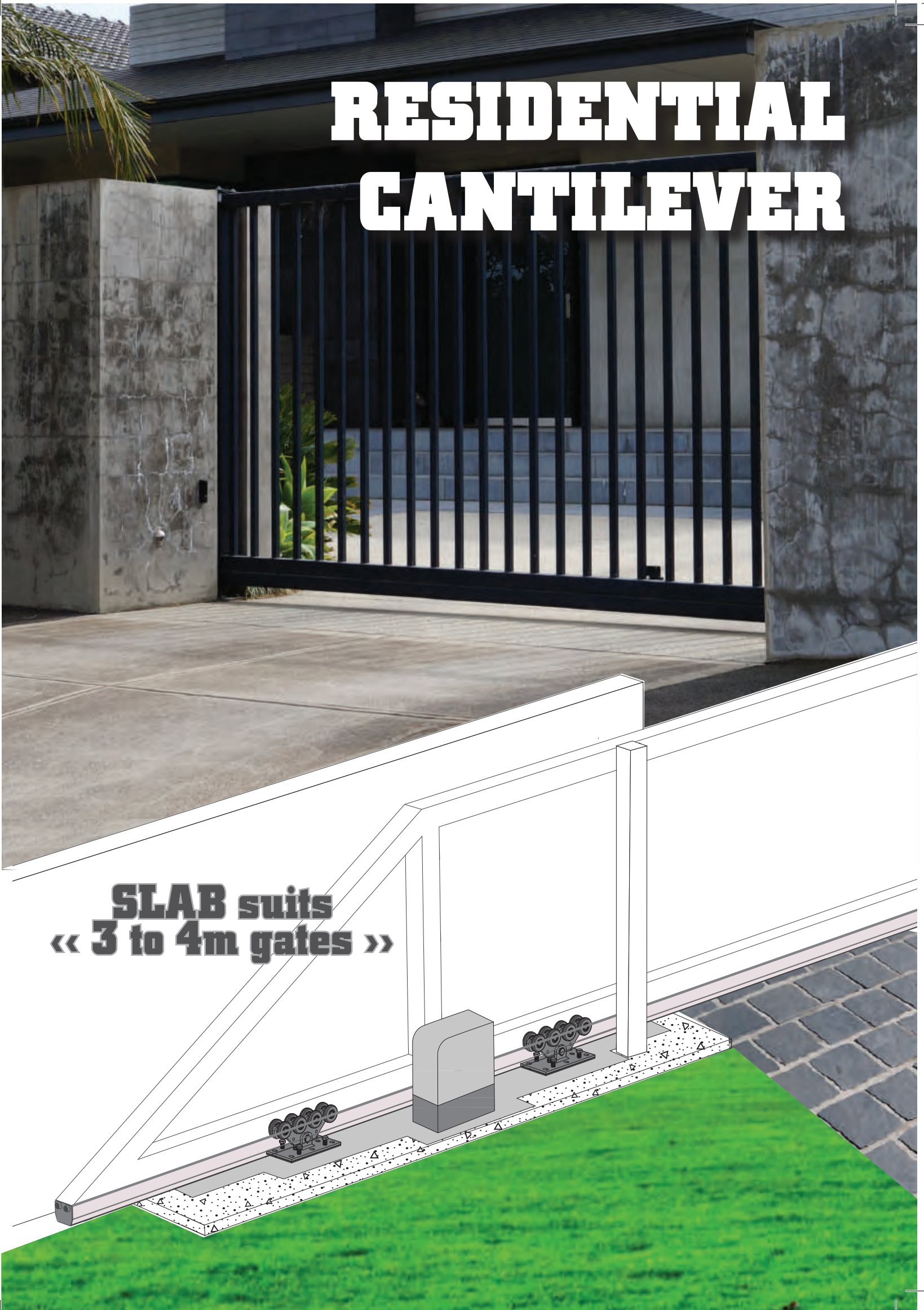

TELESCOPIC GATE

4 to 15m GATES



START PACK

Code	Description
TGK-004-START	Opening to 4m/ Max. 600kg combined leaf weight
TGK-008-START	Opening to 8m/ Max. 600kg combined leaf weight
TGK-011-START	Opening to 11m/ Max. 800kg combined leaf weight
TGK-015-START	Opening to 15m/ Max. 800kg combined leaf weight



Inline Guide Roller **Quick Coupler** **Pulley Hardware** **Pulley Covers** **Top Guide (full pack only)**

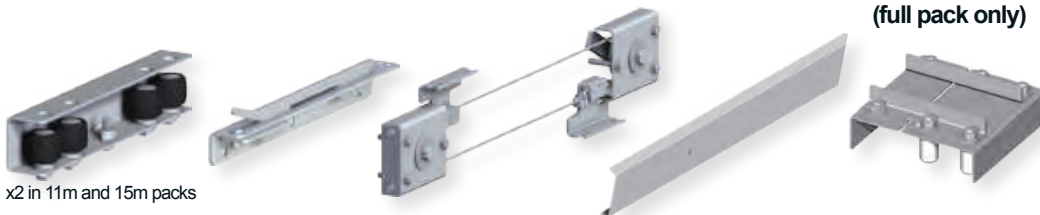

FULL PACK

Code	Description
TGK-004-FULL	Opening to 4m/ Max. 600kg combined leaf weight
TGK-008-FULL	Opening to 8m/ Max. 600kg combined leaf weight
TGK-011-FULL	Opening to 11m/ Max. 800kg combined leaf weight
TGK-015-FULL	Opening to 15m/ Max. 800kg combined leaf weight

Workshop Tip

Because Gate2 travels twice the speed as Gate1 it places a lot of strain on the motor. Meaning, telescopic gates need a bigger motor than the gate's weight.

Example:
Gate1 is 150kg +
Gate2 is 160kg (x2 = 320kg)
= 470kg EGW

Note: Telescopic gates are not to be used on sloped driveways.



DRIVEWAY H/WARE SWING GATE

Workshop Tips

Hinge ratings are based on the EGW. A 100kg gate 2m wide with hinges 2m apart needs two hinges rated at 100kg+.

The EGW is easy! You'll need the gate weight.

weight x width ÷ height = EGW

Use hinges with a combined rating higher than a gate's EGW.

ANGLE STEEL
More rigid than bent steel to avoid gate sag.



Bearing Hinge - Steel Tube

Code	Rating	Suits
VC4351-040*	150kg	40x40
VC4352-050*	300kg	50x50

* Sold as a pair.

Upper Bearing Hinge - Bolt on

Code	Rating	D
86L-P	200kg	45 Ø
85L-M	350kg	50 Ø
85L-G	500kg	70 Ø



Bottom Bearing Hinge - Bolt on

Code	Rating	D
87L-P	200kg	45 Ø
87L-M	350kg	50 Ø
87L-G	500kg	70 Ø



Upper Bearing Hinge - For Concrete Post

Code	Rating	D
85PST-M	350kg	50 Ø
85PST-G	500Kg	70 Ø
85XL	4000Kg	110 Ø



85PST

Bottom Bearing Hinge - Bolt down

Code	Rating	D
87PST-P	200kg	45 Ø
87PST-M	350kg	50 Ø
87PST-G	500kg	70 Ø
87XL	4000kg	110 Ø



87PST-P

Upper Bearing Hinge - Weld on

Code	Rating	D
86W-P	200kg	45 Ø
85W-M	450kg	50 Ø
85W-G	650kg	70 Ø



86W-P



85W

Bottom Bearing Hinge - Weld on - Concrete in

Code	Rating	D
87W-P	200kg	45 Ø
87W-M	450kg	50 Ø
87W-G	650kg	70 Ø



DRIVEWAY SWING GATE

180 Degree Gate Hinge

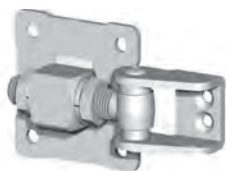

Code	Rating
236-M18	200kg
236-M22	350kg

Pintle Hinge - Bolt on



Code	Rating	Ctn
94-P	200Kg	20
94-G	300Kg	10
96-G*	300Kg	10

* Features Ball Bearing

Pintle Hinge - Weld on



Code	Rating	Ctn
92-G	300kg	10

Adjustable Pintle Hinge



Code	Rating	Ctn
100P	100kg	10
100G	200kg	10

Adjustable Clamp Hinge



Code	Rating	Use with	Ctn
186-M18	100kg	192-30	20
186-M22	160kg	192-35	10
186-M27	260kg	192-40	10



Code	size	Ctn
192-30	35 X 35	20
192-35	40 X 40	10
192-40	50 X 50	10

Square Plate with Adjustable Nut



Code	Ctn
159-M20	10

Adjustable Bolt on Pintle Hinge



Code	Rating	Ctn
161-M20	150Kg	20
161-M24	225kg	10

Adjustable Weld on Pintle Hinge



Code	Size and Rating	Ctn
155-M20	M20 - 150kg	20
155-M24	M24 - 225kg	10

Thru Bolt Pintle Hinge



Code	Rating	Ctn
130-M20	150Kg	20
130-M24	225kg	10

Heavy Duty - Weld on - Butt Hinge



Code	Rating	Ctn
445-90	800kg	10



Code	Rating	Ctn
456-180	800kg	4



Code	Rating	Ctn
460-180	800kg	4

Bolt Down Gate Stop - Zinc Plated



Code	Ctn
171	10

Bolt Down Gate Stop



Code	Ctn
300508B	25

Concrete-in Gate Stop



Code	Ctn
300508	25

2021

DOWNEE
MFG.

**GATE & FENCE
HARDWARE**



DOWNEE MFG.

In 2018 Downee celebrates our 90th anniversary as an Australian manufacturer.

As a celebration of the milestone, we've reintroduced the original Downee logo from the 1930's.

The 'Downee Mfg' logo respects the 90-years of uninterrupted manufacturing and the proud men & women responsible for our Australian made products.

To mark the our occasion 2018 catalogue features a number of references to our history.

Most notably is the man who started Downee, William 'Bill' Downey, a steel manufacturing pioneer born in Nelligen, NSW. In 1932 an article in Australasian Manufacturing titled "The Man Behind the Factory" featured Bill and his exploits of the time.

In the 1930's, during the Great Depression when unemployment peaked at 32% Bill designed and made his own rabbit trap. After which he set out in his car (pictured below with his 1927 Chrysler) across Australia traveling 13,000km in 6mths to meet distributors for the Down-ee trap. During his trip, he crossed paths with

hundreds of trappers, often stayed overnight in their camps.

With the knowledge learned from trappers, he wrote and published the booklet on how to make an income from trapping rabbits. The cover seen here are from an original copy of the booklet kept at the National Library of Australia.

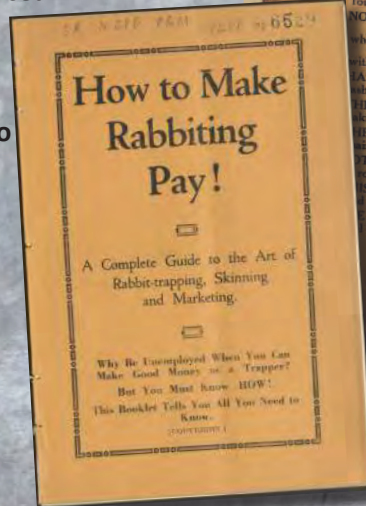

INDEX

1 CHAIN WIRE HARDWARE

- 1 Universal Rail Clamps
- 1 Universal Post Clamps
- 1 Universal Connector
- 1 Wall Bracket Assembly
- 2 Fixed Corners
- 2 Fixed Tees
- 2 Fixed Crosses
- 2 Speedee Sleeves
- 2 Spigots - Chainmesh Cages
- 2 Adjustable Corners
- 3 Flanges - Oval
- 3 Flanges - Round
- 3 Flanges - Square
- 3 Gudgeons - Long Plate
- 3 Gudgeons - Short Plate
- 3 Hinges - Two Part
- 3 Hinges - Strap Type
- 3 Hinges - Interlocking
- 3 Pipe Hinge Straps
- 3 Pipe Straps
- 4 Chainmesh
- 4 Backing Plate
- 4 Drop Bolt - Flag Pin
- 4 Drop Bolt - Security
- 4 Drop Bolt - Standard
- 4 Drop Bolt Lugs
- 4 Gate Entry Brace
- 4 Shoot Bolts
- 4 Hinge Strap Attachment
- 4 Temporary Fence Clamps
- 4 Temporary Fence Clamp Hinges
- 4 Pipe Dimension Chart

5 CAPS

- 5 Square Caps - Steel
- 5 Round Caps - Steel
- 5 Square Caps - Plastic
- 5 Round Caps - Plastic
- 5 Rectangular Caps - Plastic

7 RURAL HARDWARE

- 7 Rural - Timber Post Fittings
- 7 Gudgeons - Timber Posts
- 7 Gudgeons - Automatic Gates
- 7 Gudgeons - Anti Twist
- 7 Gudgeons - Heavy Duty
- 7 Gudgeons - Light Duty
- 7 Gudgeons - Angle Post
- 7 Pipe Hinge Straps
- 7 Adaptors For Pipe Strap
- 7 Backing Plates For Pipe Strap
- 8 Weld-On Fittings & Catches/ Latches
- 8 Weld-On Sockets
- 8 Weld-On Pins
- 8 Strap Gudgeon Hinges
- 8 Strap And Gudgeons
- 8 Catches - Ring
- 8 Catches - Hook
- 8 Catches - Gate
- 8 Chain Plates
- 8 Gate Bows
- 8 Screw Eyes
- 8 Field Gate Fasteners



- 8 Staples
- 9 Stockyard Components
- 9 Stockyard Hinges
- 9 Stockyard Clamps
- 9 Slam Catches
- 9 Slam Catch Striker Plates
- 9 Wire Strainers
- 9 Cattle Yard Cleats
- 9 Cattle Yard Pins
- 9 Cattle Yard Feet
- 10 Farm Gate Packs

11 TUBULAR FENCING

- 11 Tubular Fencing - Brackets
- 11 Rail Brackets - Aluminium
- 11 Rail Brackets - Steel
- 11 Rail Brackets - Adjustable
- 12 Rail Brackets - Security
- 12 Cover Sleeve For Security Brackets
- 12 Rail Tube End Brackets
- 12 Rail Angle Brackets
- 12 Fence Panel U Clips
- 12 Timber Rail Holder Brackets
- 12 Rail Plates
- 12 Rail Saddles
- 12 Rai Joiners
- 12 Post Brackets
- 12 Shark Fins
- 12 Flange Plates - Weld On
- 12 Base Cover - Plastic
- 13 Spears
- 14 Decorative Post Caps
- 14 Rings and Crosses

17 PEDESTRIAN GATE

- 15 Pedestrian Gate - Hinges
- 15 Hinges - Decorative
- 15 Hinges - Spring Loaded
- 15 Hinges - Ball Bearing
- 15 Hinges - Scotch T
- 15 Hinges - Butt
- 16 Pedestrian Gate - Hinge Packs
- 16 Gate Hinges - Adjustable
- 16 Gate Hinges - Tubular
- 16 Gate Hinges - Fixed
- 16 Gate Hinges - Self Closing
- 16 Gate Hinges - Heavy Duty
- 16 Gate Hinge Packs
- 17 Pedestrian Gate - Latches
- 17 Broadhurst Lock Kits
- 17 Gate Locks
- 17 Gate Lock Strikers
- 17 Coil Type Springs
- 17 Hasp And Staples
- 18 Pedestrian Gate - Latches
- 18 Latch
- 18 Strikers
- 18 Handles
- 18 D Latch/Striker Packs
- 18 Anti Rattle Sleeves
- 18 Two Way Catches
- 18 Drop Bolts - Slide Plate
- 18 Gate Pad Bolts



W. H. 'Bill' Downey
Original founder of Downee

Downee



UNIVERSAL CHAIN WIRE

Universal Rail Clamps - Galvanised

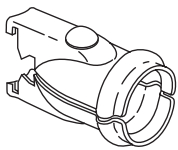

Code	Butt (NB)	Ctn
UFFB25	25	40
UFFB32	32	30
UFFB40	40	30
UFFB50	50	20

- Bolts and nuts included

Universal Post Clamps - Galvanised

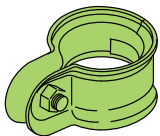

Code	Thru (NB)	Ctn
UFFT25	25	50
UFFT32	32	40
UFFT40	40	40
UFFT50	50	40
UFFT65	65	30
UFFT80	80	20
UFFT100	100	20
UFFT150	150	15

Low Clearance Wall Bracket Assembly - Galvanised

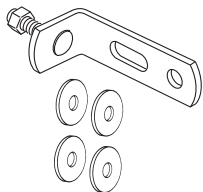

Code	Ctn
UFFLCWB	50

Used with UFFB and UFFT (all combinations) for spacing and securing post from wall. Allows easy access for wire lacing and close fitment of post to wall

- Includes:
- 1 x G20A adjustable bracket
 - 4 x M10 gal washer
 - 1 x M10 x 40 bolt

Universal Connector - Galvanised



Code	Ctn
UFFMPC	50

- Multi-purpose connector suitable with all post and rail clamps.
- Use for multi-staying of posts, corner struts, raked fences and all add-on fencing situations.

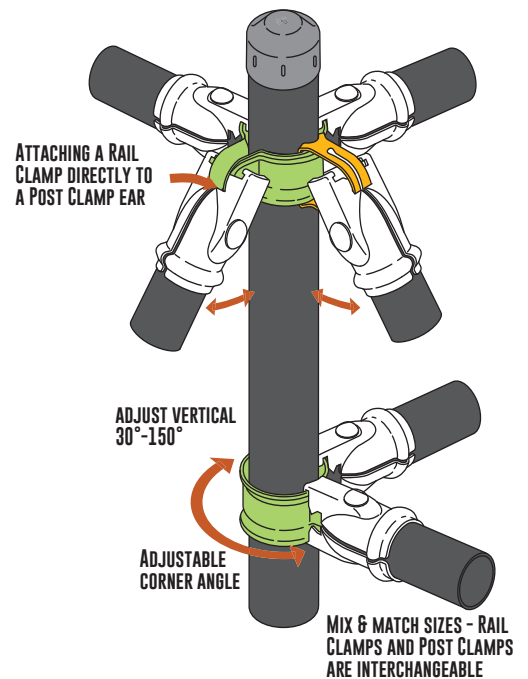

HIGH SECURITY

Spike - Galvanised

Code	Length	Ctn
RAZOR	800mm	20

- Only sold as box lots of 20.
- NOTE: Council restrictions may apply.



CHAINWIRE HARDWARE IS AVAILABLE IN BLACK POWDER COAT

CONDITIONS APPLY

Corner - Galvanised

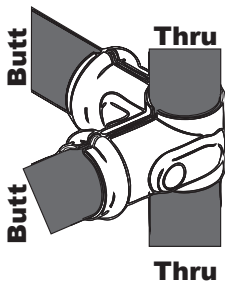

Code	Butt/Thru (NB)	Ctn
C2020	20/20	40
C2525	25/25	30
C2532	25/32	20
C2540	25/40	20
C2550	25/50	20
C3232	32/32	20
C3240	32/40	10
C3250	32/50	10
C4040	40/40	10
C4050	40/50	10
C5050	50/50	5

• Bolts and nuts included

Tee - Galvanised

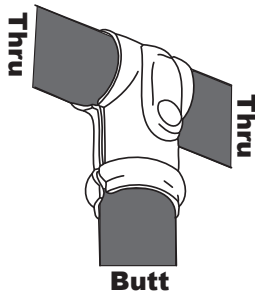

Code	Thru/Butt (NB)	Ctn
T1515	15/15	150
T2020	20/20	100
T2025	20/25	80
T2525	25/25	50
T2532	25/32	40
T2540	25/40	30
T3225	32/25	40
T3232	32/32	40
T3240	32/40	20
T3250	32/50	20
T4025	40/25	40
T4032	40/32	30
T4040	40/40	20
T4050	40/50	10
T5025	50/25	30
T5032	50/32	30
T5040	50/40	20
T5050	50/50	10
T6550	65/50	10
T8025	80/25	10
T8032	80/32	10
T8040	80/40	10
T8050	80/50	10

• Bolts and nuts included

CHAIN WIRE

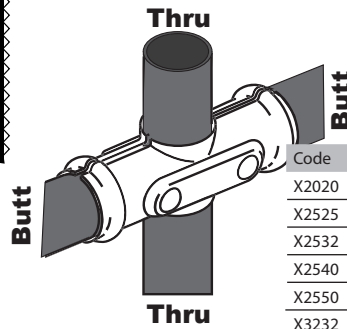

Cross - Galvanised

Code	Butt/Thru (NB)	Ctn
X2020	20/20	50
X2525	25/25	30
X2532	25/32	20
X2540	25/40	30
X2550	25/50	20
X3232	32/32	20
X3240	32/40	20
X3250	32/50	10
X4040	40/40	20
X4050	40/50	10
X5050	50/50	10
X5065	50/65	10

Speedee Sleeve - External Pipe Joiners - Galvanised

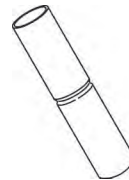

Code	Pipe (NB)	Length	Ctn
SS25	25	150	30
SS32	32	200	25
SS40	40	200	20
SS50	50	200	10

Spigot (Chain Mesh Cages) - Galvanised

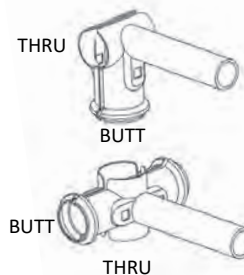

Code	Thru/Butt	Ctn	Spigot to suit NB
T2532-SPIGOT		20	25
T3225-SPIGOT		20	25
T3240-SPIGOT		20	32
T4032-SPIGOT		20	32

Code	Butt/Thru	Ctn	Spigot to suit NB
X2532-SPIGOT		20	25
X3240-SPIGOT		20	32

• Bolts and nuts included

SPIGOTS = FASTER CAGE INSTALLS!

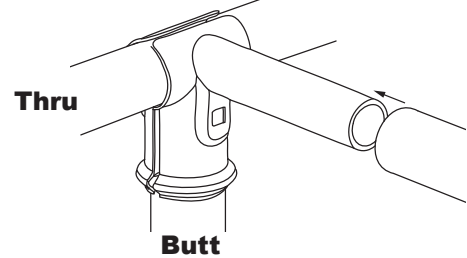

ADJUSTABLE CORNERS

Code	Butt/Thru (NB)	Ctn
AC2525	25/25	20
AC2532	25/32	20
AC2550	25/50	20
AC3232	32/32	15
AC3240	32/40	15
AC3250	32/50	15
AC4040	40/40	15
AC4050	40/50	15
AC5050	50/50	10

CHAIN WIRE

Oval Flanges - Galvanised



Code	Pipe (NB)	Ctn
F20	20	100
F25	25	100
F32	32	50
F40	40	30
F50	50	30

Round Flanges - Galvanised



Code	Pipe (NB)	Ctn
F32R	32	20
F40R	40	20
F50R	50	20

Heavy Duty Square Flanges - Galvanised



Code	Pipe (NB)	Ctn
F32H	32	30
F40H	40	30
F50H	50	20

Long Plate Gudgeon - Galvanised

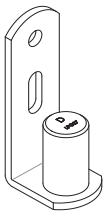

Code	Pipe (NB)	Ctn
LPG27	25	20

• 27mm Pin

Heavy Duty Short Plate Gudgeon - 50mm Steel Pin - Galvanised



Code	Pipe (NB)	Ctn
G24	20	50
G22	25	50
G23	32	30

Round Post Fittings



Code	Pipe (NB)	Ctn
G22R	25	50
S3R	25	30

Hinges - Galvanised



Clamp-On

Code	Post/Gate (NB)	Ctn
H2020	20/20	30
H2525	25/25	20
H3220	32/20	20
H3225	32/25	20
H4020	40/20	20
H5020	50/20	20

CHAIN WIRE

Hinges - Galvanised



Two Part Hinge + Attachment

Code	Post/Gate (NB)	Ctn
H4025	40/25	20
H4032	40/32	20
H5032	50/32	20

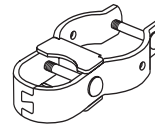

Two Part Interlocking Hinge + Attachment

Code	Post/Gate (NB)	Ctn
H5025D	50/25	20
H8025D	80/25	10
H8032D	80/32	10



Strap Type Hinge + Attachment

Code	Post/Gate (NB)	Ctn
H8040	80/40	10
H10025	100/25	10
H10032	100/32	10
H10040	100/40	10

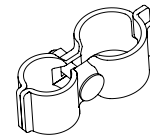

Two Part Interlocking Hinge

Code	Post/Gate (NB)	Ctn
TH3225	32/25	30
TH4025	40/25	30

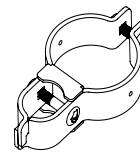

Two Part Interlocking Hinge + Attachment

Code	Post/Gate (NB)	Ctn
TH5025	50/25	20
TH8025	80/25	10
TH10025	100/25	10
TH10032	100/32	10



Gudgeon Attachment for Two Part Hinge

Code	Pipe (NB)	Ctn
HAP25	25	20
HAP32	32	10

Pipe Hinge Straps - Loose Fit - Galvanised

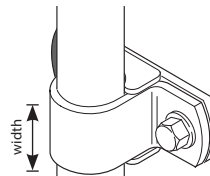

Code	Pipe (NB)/Width	Ctn
S1	20/25	100
S2	25/25	50
S3	25/40	30
S4	32/40	30
S5*	40/40	30
S6*	50/40	30

• Backing strap not available for S5 and S6

• Backing plate not available for S5 and S6

Pipe Straps - Tight Fit - Galvanised

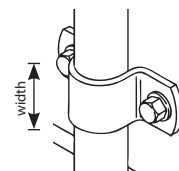

Code	Pipe (NB)/Width	Ctn
S1T	20/25	100
S2T	25/25	70
S3T	25/40	30
S4T	32/40	30
S5T	40/40	30
S6T	50/40	30

PIPE SIZE CONVERTER

PIPE SIZE nominal bore	Internal Diameter	External Diameter	
15NB	1/2"	21.3 mm	27/32"
20NB	3/4"	26.9 mm	1 1/16"
25NB	1"	33.7 mm	1 11/32"
32NB	1 1/4"	42.4 mm	1 11/16"
40NB	1 1/2"	48.3 mm	1 29/32"
50NB	2"	60.3 mm	2 3/8"

PIPE SIZE nominal bore	Internal Diameter	External Diameter	
65NB	2 1/2"	76.1 mm	3"
80NB	3"	88.9 mm	3 1/2"
90NB	3 1/2"	101.6 mm	4"
100NB	4"	114.3 mm	4 1/2"
125NB	5"	139.7 mm	5 1/2"
150NB	6"	165.1 mm	6 1/2"

Backing Plate - Galvanised

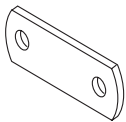

Code	Suits	Ctn
BP1	S1	100
BP2	S2	100
BP3	S3	100
BP4	S4	30

- Use with Pipe Hinge Straps

Hinge Strap Attachment - Galvanised

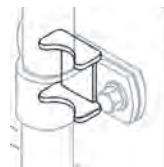

Code	Suit	Ctn
A1	S1	200
A2	S2	200
A3	S3	100
A4	S4	100

- Use with Pipe Hinge Straps

Flag Pin Drop Bolt - Galvanised

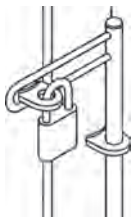

Code	Size	Ctn
FPDB900	900xø16	5
FPDB1050	1050xø16	5
FPDB1200	1200xø16	5
FPDB1500	1500xø16	5

- Lugs sold separately

TEMPORARY FENCE

Drop Bolt - Galvanised



Code	Size	Ctn
GDB260	260xø16	20
GDB370	370xø16	20
GDB430	430xø20	10
GDB600	600xø16	10
GDB850	850xø16	10

- Lugs sold separately

Security Drop Bolts - Galvanised

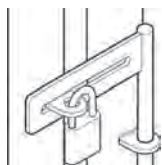

Code	Size	Ctn
FPDS900	900xø16	5
FPDS1200	1200xø16	5

- Lugs sold separately

Temporary Fence Clamp - Galvanised

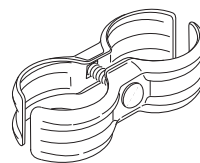

Code	Pipe (NB)	Ctn
TFCN2525	25/25	50
TFCN3232	32/32	20
TFCN4040	40/40	20
TFCN5050	50/50	20

Drop Bolt Lug - Galvanised



Code	Size	Ctn
L2	ø16	200prs
L3	ø20	150prs

- 1 x Plain + 1 x Slotted

Temporary Fence Clamp Hinge - Galvanised

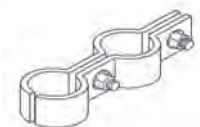

Code	Pipe (NB)	Minimum
THC4040	40/40	10
THC5050	50/50	10

Gate Entry Brace & Shoot Bolt - Galvanised

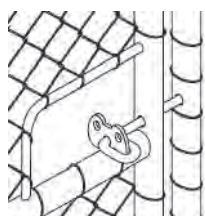

Corner Bar

Code	Length	Ctn
GEB12	190x110xø12	30
GEB11	125x110xø12	30

Shoot Bolt - Galvanised

Code	Length	Ctn
B8	150mm	30
B9	270mm	20

CAPS

CAPS

Square Tube Caps - Domed

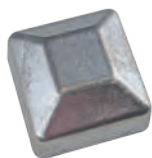

Galvabond

Code	Tube	Ctn
K25MSGB	25x25	300
K35MSGB	35x35	150
K40MSGB	40x40	150
K50MSGB	50x50	100
K60MSGB	60x60	50
K65MSGB	65x65	50
K75MSGB	75x75	60
K90MSGB	90x90	20
K100MSGB	100x100	30
K125MSGB	125x125	30
K150MSGB	150x150	20

Cast Aluminium

Code	Tube	Ctn
PC5	50x50	100
PC6	65x65	100

Round Post Caps - Galvanised - Galvabond

Galvanised



Code	Pipe (NB)	Ctn
K20	20	200
K25	25	150
K32	32	100
K40	40	80
K50	50	50
K65	65	30
K80	80	20
K90	90	20
K100	100	20

Galvabond

Code	Pipe (NB)	Ctn
K20GB	20	300
K25GB	25	150
K32GB	32	100
K40GB	40	80
K50GB	50	50
K65GB	65	30
K80GB	80	40
K90GB	90	20
K100GB	100	20
K125GB	125	20
K150GB	150	10
K200GB	200	20

Square Tube Caps - Flat - Galvabond



Code	Tube	Ctn
K90MSGBF	90x90	20
K100MSGBF	100x100	30

Square Tube Plastic Caps - Domed - Polypropylene



Code	Tube	Ctn
PC5050BL	50x50x2.0-2.5	100
PC6565BL	65x65x2.0-2.5	40

Square & Rectangular Tube Plastic Caps - Flat - Polypropylene



Standard Caps

Code	Pipe	Thickness	Ctn Qty
PC1212BL	12x12	1.6	1000
PC1919BL	19x19	1.2-1.6	500
PC2020BL	20x20	1.2-2.0	1000
PC2525BL	25x25	1.2-1.6	500
PC3030BL	30x30	1.2-1.6	300
PC3535BL	35x35	1.6	200
PC3825BL	38x25	1.2-1.6	300
PC4040BL	40x40	1.6	200
PC5025BL	50x25	1.2-1.6	200
PC5050FLAT	50x50	1.6-2.0	100
PC5735BL	57x35	1.6	100
PC6438BL	64x38	1.6-2.0	50
PC6535BL	65x35	2.0	100
PC7550F	75x50	1.6-2.0	150
PC10050F	100x50	1.6-2.0	100
PC15050F	150x50	1.6-2.0	80

Premium Caps

Code	Tube	Thickness	Ctn Qty
IPC2525	25x25	1.0-3.0	200
IPC4040	40x40	2.0-4.0	100
IPC4040-1	40x40	1.0-3.0	100
IPC5010	50x10	0.75-2.0	200
IPC5025	50x25	1.25-3.0	100
IPC5050	50x50	1.6-3.0	100
IPC5050-5	50x50	3.0-5.0	100
IPC6060	60x60	1.6-3.5	50
IPC6565	65x65	1.6-4.0	50
IPC7525	75x25	1.0-3.0	100
IPC7550	75x50	2.5-4.5	50
IPC7575	75x75	2.0-4.5	30
IPC7638	76.2x38.1	1.2-3.5	50
IPC8040	80x40	1.0-3.0	50
IPC9090	90x90	3.0-5.0	30
IPC10050	100x50	2.0-4.0	30
IPC100100	100x100	1.6-4.0	20
IPC12575	125x75	2.0-5.0	20
IPC125125	125x125	3.0-6.0	10
IPC15050	150x50	2.0-4.0	20
IPC150150	150x150	3.0-6.0	10

Round Tube - Plastic Caps - Polypropylene



Standard Caps

Code	OD Tube	Ctn Qty
PC16BL	ø16x1.2-1.6	1000
PC19BL	ø19x1.2-1.6	1000
PC22BL	ø22x1.2-1.6	1000
PC25BL	ø25x1.2-1.6	500
PC28BL	ø28x1.2-1.6	500
PC32BL	ø32x1.2-1.6	500
PC50BL	ø50x1.2-1.6	200

Premium Caps

Code	NB Pipe	Ctn Qty
IPC25NB	25NB	100
IPC32NB	32NB	100
IPC40NB	40NB	100
IPC50NB	50NB	50
IPC50OD	50OD	50
IPC60NB	60NB	50
IPC65NB	65NB	40
IPC90NB	90NB	20
IPC100NB	100NB	10

90
Downee
Years

GATE 'N' FENCE HARDWARE



Erecting polling booth beside Town Hall
with galvanised pipe and Downee fittings, 13 Sept. 1934.

From the collection of the
State Library of New South Wales.

MADE
HERE
SINCE
1928

RURAL HARDWARE

TIMBER POST FITTINGS

Timber Post Gudgeon - Screw In - Galvanised

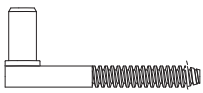

Code	Gate	Ctn
G3LP	25NB	20

Timber Post - Bolt Thru - Galvanised



Code	Gate	Post	Ctn
G7B	25NB	300	10
G8B	25NB	400	10
KQ2	32NB	300	10
KQ1	32NB	400	10



Code	Gate	Post	Ctn
G7AT	25NB	300	15



Code	Gate	Post	Ctn
G7LT	25NB	300	15

Deluxe Hinge - Suitable for automatic gates

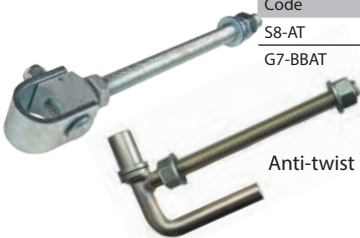

Code	Gate	Post	Ctn
S8-AT	25NB	200	ea
G7-BBAT	25NB	200	ea

Anti-twist

Timber Post Strap - Bolt Thru - Galvanised



Code	Gate	Post	Ctn
S7C	25NB	300	10
S8C	25NB	400	10



Code	Gate	Post	Ctn
KQS25	32NB	300	5
KQS15	32NB	400	5



Code	Gate	Post	Ctn
S7B	25NB	300	10
S8B	25NB	400	10

Heavy Duty Short Plate Bolt Gudgeon - 50mm Steel Pin - Galvanised

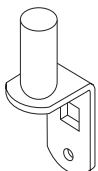

Code	Pipe (NB)	Ctn
G24	20	50
G22	25	50
G23	32	30

TIMBER POST FITTINGS

Light Duty Short Plate Bolt Gudgeon - Galvanised

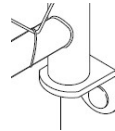

Code	Pipe (NB)	Ctn
G43	32	40

Pipe Hinge Straps - Galvanised



Code	Pipe/Width (NB)	Ctn
S1	20/25	100
S2	25/25	50
S3	25/40	30
S4	32/40	30



Code	Suit	Ctn
A1	S1	200
A2	S2	200
A3	S3	100
A4	S4	100



Code	Suits	Ctn
BP1	S1	200
BP2	S2	100
BP3	S3	100
BP4	S4	30

Angle Post Gudgeon and Strap - Galvanised



Code	Gate	Ctn
APS25	25NB	40
APG25	25NB	20



APG25

Round Post Gudgeon and Strap - Galvanised



Code	Pipe (NB)	Ctn
S3R	25	30
G22R	25	30



G22R

Timber Post Gudgeon - Galvanised



Code	Pipe (NB)	Ctn
TPG25	25	20

Timber Post Gudgeon - Long Plate - Steel Pin - Galvanised



Code	Pipe (NB)	Ctn
LPG27	25	20
G12	20	50
G13	25	50

WELD ON FITTINGS

Weld on Socket - Zinc Plated



WOS Socket



WOP Pin

Code	Type	Pin	Ctn
WOS12	Socket	12	100
WOP12	Pin	12	100
WOP12A	Assembly	12	100
WOS16	Socket	16	50
WOP16	Pin	16	50
WOP16A	Assembly	16	50
WOS20	Socket	20	30
WOP20	Pin	20	30
WOP20A	Assembly	20	20
WOP20LA	Assembly	20	20
WOS20L	Socket	20	30
WOP20L	Pin	20	30
WOS27	Socket	27	10
WOP27	Pin	27	10
WOP27A	Assembly	27	10

Strap Gudgeon Hinge - Galvanised



Code	Post size	Ctn
SGH080	80NB	10
SGH100	100NB	10
SGH150	150NB	5

• Use with WOS20 (sold separately)

Weld-On Strap and Gudgeon - Zinc Plated



Code	Suit	Ctn
RGWS25	25NB	50
RGWS25G	25NB	50



Weld-On Ring Catch



RWOK

Code	Ctn
RWOK	100
CAC4-2	40



CHAIN CATCH - CAC4-2

Weld-On Hook Catch



RWOL

Code	Ctn
RWOL	100
FGF1	30



CHAIN CATCH - FGF1

Weld-On Chain Plate - Zinc Plated



Code	Suits	Ctn
SCP5MM	5-6mm chain	60
SCP8MM	8mm chain	40

Double Gate Ring Catch - Galvanised

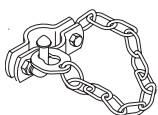

Code	Suit	Ctn
DGCL25	25NB	15
DGCL32	32NB	10

CATCHES AND LATCHES

Double Gate Hook Catch - Galvanised



Code	Suit	Ctn
KDGH25	25NB	10
KDGH32	32NB	10

Double Gate Catch - Zinc Plated



Code	Suit	Ctn
FDG25	25NB	20

Timber Post Gate Catch - Galvanised



Code	Size	Ctn
CAC1	ø12	30
CAC2	ø16	20

Steel Post Gate Catch



Code	Ctn
CAC4	20

Bow Latch - Galvanised



Code	Suits	Ctn
KDGB25	25NB	5



Code	Suits	Ctn
CAC22	25NB	15

Screw-In and Weld-On Eyes - Zinc Plated



Screw In		
Code		Ctn
SE12	12mmø x 75mm	30



Weld-On		
Code		Ctn
SE12W	12mmø x 75mm	30

Field Gate Fastener with chain - Galvanised



Code	Size
FGF1	350mm chain
FGF2	500mm chain



Drive in Staple	
Code	Ctn
FGS	100



Pack - includes hook, chain & 2 staples		
Code		Ctn
FGF1S	350mm chain	20

STOCK YARD PARTS

STOCKYARD COMPONENTS

Stock Yard Hinges - Galvanised



Code	Pipe	Width	Ctn
SYH5025	50x25 NB	40mm	10
SYH5032	50x32 NB	40mm	10
CYH8032	80x32 NB	65mm	5

Stock Yard Clamps - Galvanised



Code	Pipe	Width	Ctn
TFC4040	40x40 NB	40mm	20
SYC5025	50x25 NB	40mm	20
SYC5032	50x32 NB	40mm	20
TFC5050	50x50 NB	40mm	20
CYC8050	80x50 NB	65mm	10

Slam Catch - Zinc Plated



Code	Pin Size	Ctn
SCJ-10	10 dia	30
SCJ-14	14 dia	10
SCJ-20	20 dia	10



Code	Pin Size	Ctn
SCJ-25	25 dia	5

Slam Catch Striker Plate - Zinc Plated



Code	Suits	Ctn
SPZ-10	SCJ-10	100
SPZ-14	SCJ-14	50
SPZ-20	SCJ-20	20
SPZ-25	SCJ-25	20

Wire Strainer



Code	Description	Ctn
12106	Wire strainer	25

Cattle Yard Cleat and Pin Set - Zinc Plated



Code	Ctn
CYCPP	20

- Includes:
 - CYPG
 - RAB40C
 - RAB40L

Cattle Yard Full Cleats - Zinc Plated

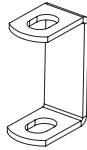

Code	Width	Ctn
RAB50C	50mm	38
RAB40C	40mm	38

Cattle Yard Half Cleats - Zinc Plated

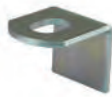

Code	Width	Ctn
RAB50L	50mm	50
RAB40L	40mm	50

Cattle Yard Panel Feet - Zinc Plated



Code	Width	Ctn
RAB50F	50mm	40
RAB40F	40mm	60

Cattle Yard Round Full Cleats - Zinc Plated



Code	Suits	Ctn
RAB40RC	32,40,50 NB	38
RAB30RC	25, 32 NB	38

Cattle Yard Round Half Cleats - Zinc Plated



Code	Suits	Ctn
RAB40RL	32,40,50 NB	50
RAB30RL	25 NB	50

Cattle Yard Pin - Galvanised



Code	Size	Ctn
CYPG	16 dia 275x60mm	30

FARM GATE PACKS

Gate Pack - 25NB Bolt Thru - Timber Post

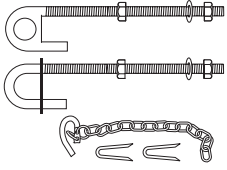

Code	Post	Pipe	Ctn
FGP753	300mm	25NB	5

Gate Pack - 25NB Bolt Thru - Timber Post

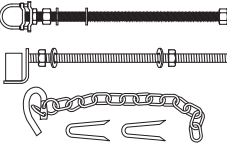

Code	Post	Pipe	Ctn
FGP303	300mm	25NB	5
FGP413	400mm	25NB	5

Clamp on Hinge Pack



Code	Post	Pipe	Ctn
FG6	100mm	25NB	5
FG6-80	80mm	25NB	5

Gate Pack - 25NB Screw In - Timber Post

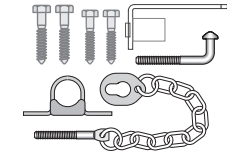

Code	Pipe	Ctn
FGP225	25NB	10

Gate Pack - 25NB - Timber Post



Code	Post	Pipe	Ctn
FGP151	300mm	25NB	5

Gate Pack - 25NB - Timber Post

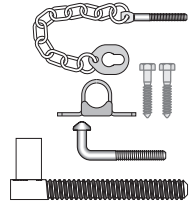

Code	Pipe	Ctn
FGP121	25NB	10

Gate Pack - 25NB Bolt Thru - Timber Post

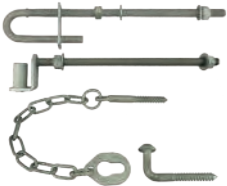

Code	Post	Pipe	Ctn
FGP351	300mm	25NB	10
FGP431	400mm	25NB	10

Gate Pack - 25NB Bolt Through - Concrete Post

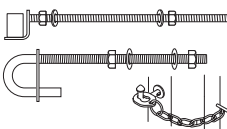

Code	Pipe	Ctn
FGP354	25NB	5

FARM GATE PACKS

Gate Pack - 25NB Bolt-on

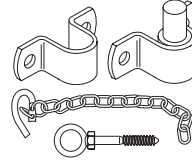

Code	Pipe	Ctn
FGP523	25NB	10

Gate Pack - 25NB Weld-on

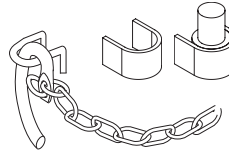

Code	Pipe	Ctn
FGP886	25NB	10

Gate Pack - 25NB Bolt-on/Weld-on - Timber and Steel Post

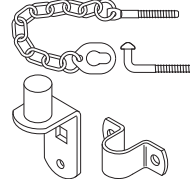

Code	Pipe	Ctn
FGP232	25NB	10

Gate Pack - 25NB Angle Post

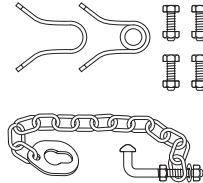

Code	Pipe	Ctn
FGP664	25NB	10

Gate Pack - Anti Twist

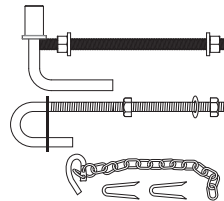

Code	Post	Pipe	Ctn
FGP191	300mm	25NB	10
FGP195	300mm	32NB	5

Gate Pack - 25NB Bolt-on

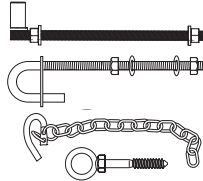

Code	Pipe	Ctn
SP1B	25NB	5

Gate Pack - 25NB Screw in

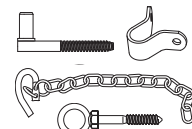

Code	Pipe	Ctn
EG1B	25NB	5

TUBULAR FENCING

TUBULAR - ALUMINIUM

Rail Brackets - Cast Aluminium

Horizontal - Single Lug - 1 Fixing Hole

Code	Rail	Ctn
FB25H	25x25	180
FB30H	30x30	150

Horizontal - Single Lug - 2 Fixing Holes

Code	Rail	Ctn
FB38H	38x25	120

Plain - Single Lug - 2 Fixing Holes

Code	Rail	Ctn
FB38P	38x25	90
FB40P	40x40	80
FB50P	50x50	40

Vertical - Single Lug

Code	Holes	Rail	Ctn
FB38V	2	38x25	120

Horizontal - Double Lug - 2 Fixing Holes

Code	Rail	Ctn
FB25HDL	25x25	150
FB30HDL	30x30	130

Plain - Double Lug - 2 Fixing Holes

Code	Rail	Ctn
FB2538PDL	25x38	100

Plain - Double Lug - 4 Holes + Security Fixing Hole

Code	Rail	Ctn
FB50PDL	50x50	25

TUBULAR - STEEL

Rail Brackets - Single Lug - Steel - Zinc Plated

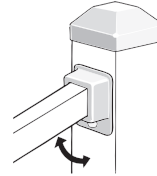

Code	Rail	Holes	Ctn
RFB2525-ZZ	25x25	2	100
RFB3030-ZZ	30x30	2	100
RFB3825-ZZ	38x25	2	100

Rail Brackets - Double Lug - Steel - Zinc Plated



Code	Rail	Holes	Ctn
DFB2525-ZZ	25x25	2	100
DFB3030-ZZ	30x30	2	100
DFB3030-2DZ	30x30	2 Diag	100
DFB3825-ZZ	38x25	2	100
DFB3825-2DZ	38x25	2 Diag	100
DFB4040-ZZ	40x40	2	100
DFB4040-2DZ	40x40	2 Diag	100
DFB4040-4Z	40x40	4	100

Adjustable Rail Bracket & Adaptor



Adjustable Rail Bracket - 2 Fixing Holes

Code	Rail	Ctn
RBA2525	25x25x1.2-1.6	50



Adaptors - Click Fit to Rail Bracket

Code	Rail	Ctn
AD3030	30x30x1.2-1.6	100
AD3825	38x25x1.2-1.6	100
AD4040	40x40x1.2-1.6	100

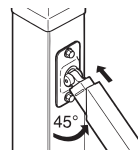

- For 30x30, 38x25 & 40x40 rails an appropriate adaptor attached to rail bracket is required.
- Australian Design Registered

NOTE: Adjustable Rail Bracket and Adaptor sold separately

TUBULAR

Security Rail Brackets - Galvanised



Code	Tube	Ctn
SRB620-92SV	30x30	50
SRB620-92	40x40	50
SRBA628-92*	40x40	50



- *Adjustable.
- *attach to post and rail by pop rivetting.



Cover Sleeve - To Suit SRB620-92

Code	Ctn
CUSMS	200

Rail Tube End Brackets - Galvabond



Code	Suits	Ctn
TEB3825	38x25x1.6	100

Rail Angle Brackets

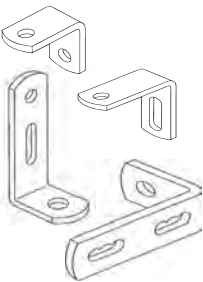

Code	Material	Size
RAB2030A	ALU	20x30x20
RAB3030	GAL	30x30x20
RAB30X30A	ALU	30x30x20
RAB35X35	GAL	36x36x20
RAB3050	GAL	30x50x20
G14	GAL	114x50x30

Fence Panel 'U' Clips

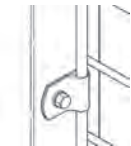

Code	Finish	Ctn
UC8/10	Galvabond	500
UC8/10G	Galvanised	500

- Clip width 25mm

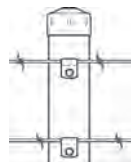

Code	Ctn
FITS/TEK20PP	20

- Contains 20 of UC8/10G and 20 14x10x25 self drilling screws.

Timber Rail Holder Bracket - Galvanised

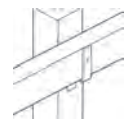

Code	Suits	Ctn
RHB7553P	75x53 Timber	50

Timber Rail Joiner Bracket - Galvabond



Code	Dimensions	Ctn
J7154	120x7x54	50

TUBULAR

Rail Plated - Galvanised

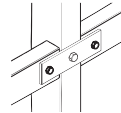

Code	Dimensions	Ctn
G86	153x40x5	50

Rail Saddles - Galvabond

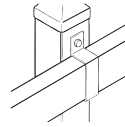

Code	Suits	Ctn
RS3825	38x25	100
RS4040	40x40	100

Rail Joiners - Galvabond

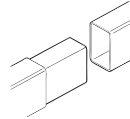

Code	Suits	Ctn
RJ3825	38x25x1.6	50

Post Brackets - 50x50x1.6 Tube - Galvanised

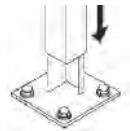

Code	Type	Ctn
PB130-C	4 hole, centered	4
PB130-O	4 hole, offset	4



Code	Type	Ctn
PB13050	2 hole	12

Shark Fin - Galvanised

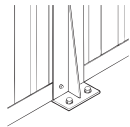

Code	Base	Ctn
SF1	150x100	5

Flange Plate - Weld on



Code	Dimensions	Ctn
F130S50	130x130x5	20

Galvanised

Code	Size	Holes	Ctn
F100SP	100x100x5	4	40
F130SP	130x130x5	4	20
RFP11350-2	113x50x5	2	20
RFP15075-2	150x75x5	2	30
RFP20095-2	200x95x8	2	10
RFP13090-4	130x90x5	4	20
RFP150100-4	150x100x5	4	20

Zinc Plated

Code	Size	Holes	Ctn
RFP13080-2	130x80x5	2	30
RFP130100-4	130x100x5	4	20
RFP130130-4	130x130x10	4	10

Base Cover

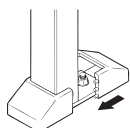

Code	Ctn
PLASTICBLA	30

- Comes ready to fit 38x25 posts. Snap out panels allow fittings to suit 40x25, 40x40, and 50x50 posts.
- Suits RFP11350-2 Flange Plate.

SPEARS - Aluminium

Fleur De Lis - Female



Code	To Fit	Size	Ctn
SPJ19	ø15.9	100x68	125
SPJ1	ø16	100x68	125
SPJ15	ø19	100x68	125

Fleur De Lis - Male



Code	To Fit	Size	Ctn
SPJ13	ø15.9x1.2 ø16x1.2	100x68	125
SPJ7	ø19x1.2	100x68	125
SPJ17	19SQx1.2 20SQx1.6	100x68	125

Cardinal - Female



Code	To Fit	Size	Ctn
SPQ19	ø15.9	110x30	100
SPQ1	ø16	110x30	100
SPQ15	ø19	110x30	100

Bishop - Female



Code	To Fit	Size	Ctn
SPM83	ø19	170x98	40

Melrose - Female



Code	To Fit	Size	Ctn
SPT31	ø15.9	150x30	80
SPT9	ø16	150x30	80
SPT33	ø19	150x30	80

SPEARS - Aluminium

Melrose - Male



Small

Code	To Fit	Size	Ctn
SPT13	ø15.9x1.2 ø16x1.2	110x28	180
SPT7	ø19x1.2	110x28	150
SPT17	19SQx1.2 20SQx1.6	110x28	200

Large

Code	To Fit	Size	Ctn
SPT36	ø15.9x1.2 ø16x1.2	150x38	80
SPT38	ø19x1.2	150x38	80
SPT37	19SQx1.2	150x38	80
SPT42	25.4SQx1.6	150x38	80
SPT43	25.4SQx1.2	150x38	80

Camden - Female



Code	To Fit	Size	Ctn
SPW9	ø16	150x62	60
SPW33	ø19	150x62	60

PICKET TOPS - Aluminium

Windsor



Code	Size	To Fit	Ctn
PITWIN	100x55	75x16x0.9	60

Kenilworth



Code	Type	Size	To Fit	Ctn
PITFLAT	Low Profile	50x5	50x10x0.9	400



Code	Type	Size	To Fit	Ctn
PITKENISR	Round	50xR25	50x10x0.9	350

Stonnington

Code	Type	Size	To Fit	Ctn
Stonnington Large - For use with Aluminium tube				
PITSTONLP	Plain	140x65	65x16x1.2	60
PITSTONLF	Fancy	140x65	65x16x1.2	60



POST CAPS - Aluminium

Ball - Square Tube - Male



Code	To Fit	Approx Size
PT50M	50x50x1.6	105xø53
PT65M	65x65x1.6-2.5	115Hxø65
PT75M	75x75x2.3-4.0	125Hxø75
PT100M	100x100x2.5-4.0	165Hxø100

Victorian Post Cap



Code	To Fit	Size
PTVPC100	100SQ	230 High
PTVPC100-S	100SQ	230 High
PTVPC125	125SQ	290 High

PTVPC100 - Fits to top of post (recommend using with a flat, steel cap)
PTVPC100-S - Hollow base - Fits over post

* Victorian Spear Kit: spear 150 high + Stud + Nut (cap not included). Cap with min. 44ø area



Victorian Spear

ACCESSORIES - Aluminium

Fence Panel Rings - Aluminium with Mill Finish



Code	Size	Ctn
FPRZ78-8	78x8	100
FPRZ90-8	90x8	100

Fence Panel Rings - Steel with Zinc Coating



Code	Size	Ctn
FPRZ78-8	78x8	100
FPRZ82-8	82x8	100
FPRZ90-8	90x8	100

Decorators

2 part interlocking - Steel



Code	Size	Ctn
DFCZ	120x120	100

PEDESTRIAN GATE

PEDESTRIAN GATE HINGES

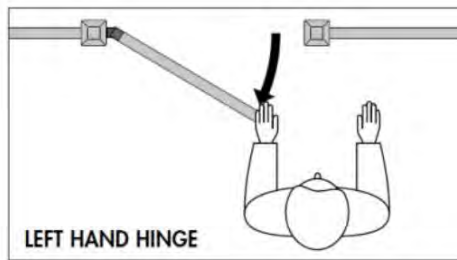

LEFT HAND HINGE

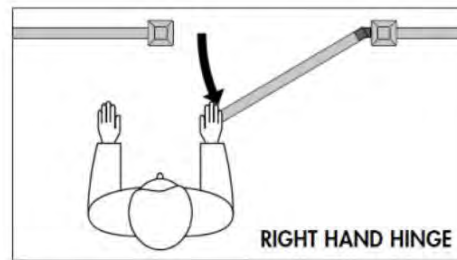

RIGHT HAND HINGE

GATE HINGE TERMINOLOGY

Rising Hinges - Zinc Plated



Zinc Plated

Code	Ctn
G7R	1 pr
G7L	1 pr

• Both Top & Bottom hinges provided

Ball Bearing Hinges - Heavy Duty - Weld on - Hinge - Zinc Plated

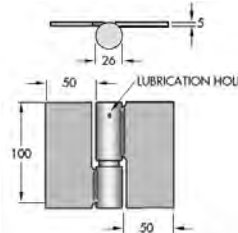

Code	Ctn
G121R	5pr
G121L	5pr

Weld On - Drop Hinge



Code	Rating	Ctn
497-100	100kg	16

• Includes brass pivot, washer & bearing

Ball Bearing Hinges - Loose Pin - Zinc Plated

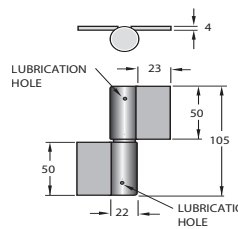

Code	Ctn
G4DR	10pr
G4DL	10pr

Decorative Drop Hinge



Code	Ctn
440-150	100kg
440-125	80kg

Spring Loaded Hinges

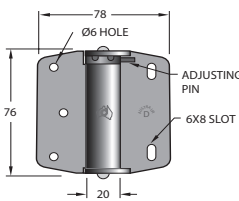

Code	Ctn
PH75	Zinc Plated 30 pr
PH75SS	Stainless Steel 30 pr

Ball Bearing Gate Hinges - Bolt-on - Fixed Pin

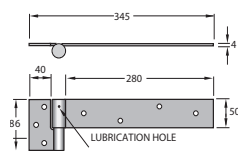

Zinc Plated		Code	Ctn
		G1R	12 pr
		G1L	12 pr
Galvanised		Code	Ctn
		G1RGAL	12 pr
		G1LGAL	12 pr

Bolt on Ball Bearing Hinges

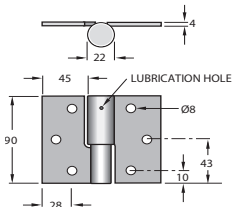

Zinc Plated		Code	Ctn
		G8R	20 pr
		G8L	20 pr
Galvanised		Code	Ctn
		G8RGAL	20 pr
		G8LGAL	20 pr

Scotch T Hinges - Galvanised - Brass Pin

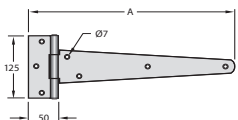

Code	A	Ctn (pr)
H150G	150 mm	20
H200G	200 mm	20
H250G	250 mm	10
H300G	300 mm	5

Ball Bearing Hinges

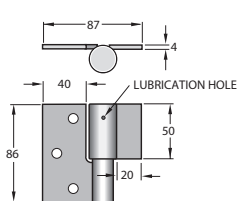

Zinc Plated		Code	Ctn
		G4R	20 pr
		G4L	20 pr
Galvanised		Code	Ctn
		G4RGAL	20 pr
		G4LGAL	20 pr

Butt Hinges

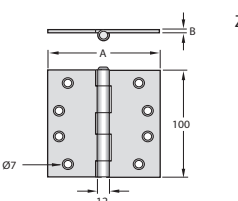

Zinc Plated		Code	Size	Ctn
		HFP100X75	100x75	20 pr
		HFP100X100	100x100	30 pr

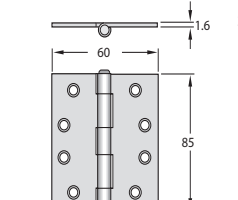

Stainless Steel		Code	Size	Ctn
		HSS10075	100x75	20 pr
		HSS100100	100x100	10 pr
		Code	Size	Ctn
		NBZP8560	85x60	50 pr

PEDESTRIAN GATE

Heavy Duty Adjustable Tubular Gate Hinge - Zinc Plated

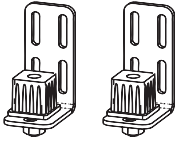

Code	Gate frame	Ctn
LBGA40	40x40	10pr
LBGA3825	38x25	10pr

Gate Hinge - Fixed Pin - Zinc Plated

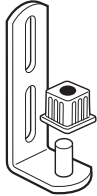

Code	Ctn
TGP100	50

Gate Hinge - Adjustable Pin - Zinc Plated

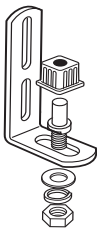

Code	Ctn
TGP110	50

Self Closing Gate Hinge - Fixed Pin - Zinc Plated



Code	Ctn
TGP120	25

Single Gate Packs

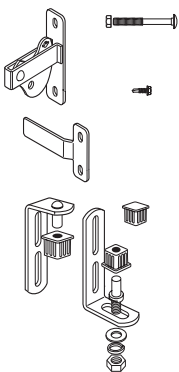

Code	Ctn
SGP	10

PEDESTRIAN GATE

Double Gate Pack - Zinc Plated

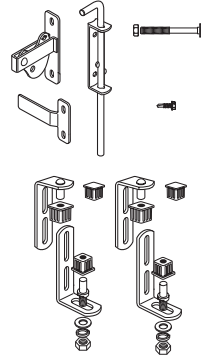

Code	Ctn
DGP	5

Gate Hinge Packs - Zinc Plated

Fixed Hinges - Top & Bottom

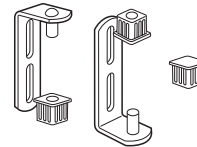

Code	Ctn
TGP230	30

Fixed Top - Adjustable Bottom

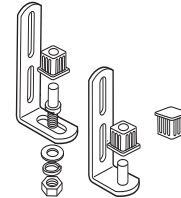

Code	Ctn
TGP240	20

Self Closing Gate Hinge Packs - Zinc Plated

Fixed Top Self Closing - Fixed Bottom

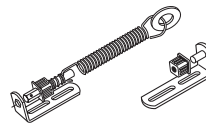

Code	Ctn
TGP250	20

Adjustable Top - Fixed Self Closing Bottom

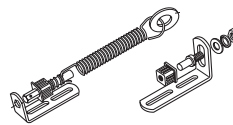

Code	Ctn
TGP260	20

HINGE PACKS

Include bushes to suit:

25 x 25 x 1.2 tube

30 x 30 x 1.2 tube

38 x 25 x 1.2 tube

LATCHES

Broadhurst Lock Kits

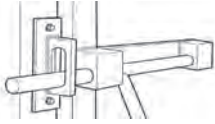

Code	Description	Ctn
BHL	Broadhurst lock	ea
BHLDBL*	Double lock box kit	ea
BHLLB	lock box	ea

- *CONTENTS DOUBLE LOCK BOX KIT
- 2 x Lock Boxes
 - 1 x Slide Bar
 - 1 x Slide Bar Catch For Single Gate
 - 1 x Slide Bar Catch for Double Gates
 - 1 x Lock Box Plate

Gate Lock - Black



Code	Gate Frame
73-40BLACK	40
73-50BLACK	50

Gate Lock - Mill



Code	Gate Frame
73-40MILL	40
73-50MILL	50

Residential Stylish Handle



Code	Suit
COM213	73-40 and 73-50

Plain Handle Kit - Alloy - Black Powder Coat Finish



Code	Suit
PBL	73-40 and 73-50

Aluminium Striker for Gate Lock 73



Code
73-AS

LATCHES

Coil Type Spring - Zinc Plated



Code	Description
G305	360mm Long
389-280	280mm Long

- Tension Adjuster and Lock Pin

Hasp & Staple - Heavy Duty - Zinc Plated

Code	Size
G58	183 x 48



LATCHES

Bolt-On 'D' Latches & Strikers - Flat

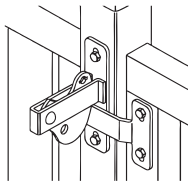

Zinc Plated

Code		Ctn
CAC28	Latch	50
BTS28	Striker	50
BTS29	Striker (offset)	50

Galvanised

Code		Ctn
CAC28G	Latch	50
BTS28G	Striker	50

Stainless Steel

Code		Ctn
DLKSS	Latch & striker	50

Pack Set - Latch, striker and handle

Code	Finish	Ctn
DLKPP	Zinc	30
DLKSSPP	Stainless steel	30
DLKPP-C	Black	30

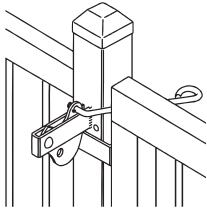

'D' Latch & Strikers - Round Post/Gate Frame - Bolt on - Zinc Plated

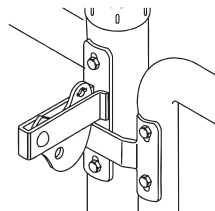

Code	Description	Ctn
CAC29	Latch	50
BTS28R	Striker	50

'D' Latch & Strikers - Weld on - Zinc Plated

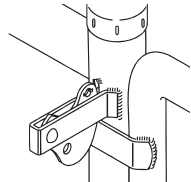

Code		Ctn
CAC26	Latch - suit RND post	100
CAC26WS	Striker - suit RND gate frame	100
CAC27WS	Striker - suit SQR gate frame	50

'D' Latch Handles

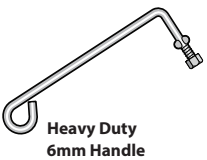

Zinc Plated

Code	Length	Handle Type	Ctn
TB28-170MK2	170	6mm H/Duty	50
TB28-230	230	5mm	50
TB28-230MK2	230	6mm H/Duty	50

Stainless Steel

Code	Length	Ctn
TB28-170SS	170	50

Striker Anti Rattle Sleeve - Black Vinyl

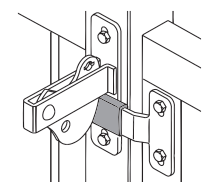

Code	Suits	Ctn
SARS	All Strikers	50

LATCHES

Two Way Catches - Zinc Plated

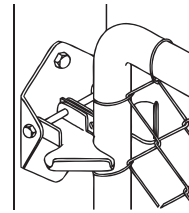

Code	Suits	Ctn
CAC5	20NB	20
CAC6	25 / 32 NB	20

- Catch can be made 'one way' by moving the locking fixture to one end

Drop Bolt + Slide Plates - Locking

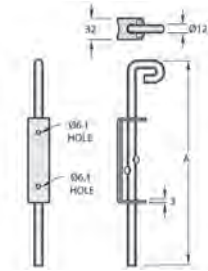

Code	Bolt Length	Ctn
B13L	300	30
B15L	400	20
B15LG*	400	20
B17L	500	20

- * B15LG - galvanised

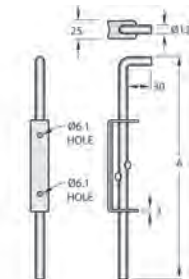

Code	Bolt Length	Ctn
B12	310	30
B14	410	30

Gate Pad Bolts

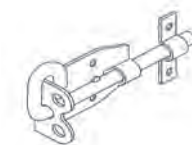

Zinc Plated

Code	Bolt length
G17G	100
G18D	150
GPBL10	210

Galvanised

Code	Bolt length
G17GGAL	100x65

Bolt-On 'D' Latch - Stainless Steel



Code	Description
GRAMLS	Latch & Striker
RGRAMHAN	Handle

- Handle is universal - can be used for right or left side

downee.com.au

VIC/TAS

70 William Angliss Drive
LAVERTON NORTH 3026

Sales & Service 03 9300 5160

Accounts: 03 9300 5177

Tech Support: 1800 241 733

Fax: 03 9311 2030

team@downee.com.au

NSW/ACT

Unit 6, 1002 Canley Vale Road
WETHERILL PARK 2164

T: 02 8785 5800

F: 02 9725 3488

nswsales@downee.com.au

QLD

Unit 18/140 Wecker Road
MANSFIELD 4122

T: 07 3434 3400

F: 07 3349 0567

qldsales@downee.com.au

SA/NT

505 Cross Keys Road,
CAVAN 5094

T: 08 8139 4720

F: 08 8349 7449

sasales@downee.com.au

WA

45 Millrose Drive,
MALAGA 6090

T: 08 9241 7300

F: 08 9209 3693

wasales@downee.com.au

NZ

331B East Tamaki Road,
East Tamaki

T: (+64) 09 277 0040

F: (+64) 09 277 0140

admin@rmdnz.co.nz

FREIGHT TERMS

Minimum order values apply for free delivery and are determined by region. Long product is also subject to additional freight charges.

PAYMENT DETAILS

ACCOUNT NAME:
RMD INDUSTRIES PTY LTD
BSB: 083-355
ACCOUNT NUMBER: 515168064

A surcharge of 1.3% will be charged on credit card transactions

GST

All prices quoted in this catalogue are in AUD and are exclusive of GST

The images in this catalogue are provided as a guide only.